



Giltrap WideTrac Spreader

Operation & Parts Manual

Part Number: 13644



**NEW ZEALAND (HEAD OFFICE)
GILTRAP ENGINEERING LTD**

7 Main North Road
Otorohanga
3900

TEL: [+64 7 873 4199](tel:+6478734199)
FAX: [+64 7 873 8131](tel:+6478738131)
FREE: [0800 804 458 \(NZ ONLY\)](tel:0800804458)
GENERAL: info@giltrapag.co.nz
PARTS: parts@giltrapag.co.nz
WEBSITE: www.giltrapag.co.nz

**AUSTRALIA
GILTRAP AG EQUIPMENT PTY LTD**

105-117 Boundary Road
Laverton North
Melbourne
Vic 3026

TEL: [+61 3 936 96 548](tel:+61393696548)
FAX: [+61 3 936 96 549](tel:+61393696549)
FREE: [1800 127 030 \(AU ONLY\)](tel:1800127030)
SALES: sales@giltrapag.com.au
PARTS: melboffice@giltrapag.com.au
WEBSITE: www.giltrapag.com.au

Disclaimer

Although every endeavour has been made to compile as near to complete records as possible for the machine described, it is possible some information is incomplete or missing.

Giltrap Engineering request that you treat this book as a guide only and offer any assistance necessary to procure the information or part you may require.

For parts or service enquiries, please contact the applicable numbers on the previous page.

Produced November 2023

Copyright © 2023 by Giltrap Engineering Ltd.

Printed in New Zealand

All rights reserved. Reproduction or use, without express permission, of editorial or pictorial content, in any manner, is prohibited.

Contents

DISCLAIMER	2
INTRODUCTION	5
DELIVERY	5
WARRANTY	6
SERIAL NUMBER IDENTIFICATION	7
GENERAL SAFETY	8
PRE-SERVICE GUIDELINES & SETTINGS	11
INITIAL SETUP	12
HYDRAULIC REQUIREMENTS	12
COUPLING THE HYDRAULICS	12
POWER.....	12
BASIC SPREADER MAINTENANCE	13
ADJUSTING THE CONVEYOR BELT	13
GREASING THE MACHINE	14
BULK DENSITIES ROUGH GUIDE	14
MEASURING BULK DENSITY OF PRODUCT	16
GENERAL OPERATION	17
DENSITY	17
SPREADING WIDTH.....	17
SPREAD RATE.....	17
SETTING SPINNER SPEED.....	18
SPREADING DISPLAY	18
MACHINE SETUP & CALIBRATION	19
LEDS AND WARNING MESSAGES	20
REMOTE CONTROL KEY FOB	21
SETTING REMOTE CONTROL DIP SWITCHES	22
FINE TUNE SETTING	23
DOOR TUNING	24
MANUAL MOVEMENT OF ACTUATOR/DOOR	25
MANUAL MOVEMENT OF FLOOR	26

GPS MAPPING SWITCH	27
PLUMBING DIAGRAM	28
PARTS BOOK SECTION	29
TRANSFERS & LABELS.....	30
ELECTRONIC COMPONENTS.....	31
HYHCV3484-1 (STANDARD).....	33
HYHCV3484 (OPTIONAL SPINNER REVERSE).....	34
RETURN LINE CHECK VALVE	35
BIN & PANELS.....	36
FLOOR DRIVE COMPONENTS – IDLER ASSEMBLY AND BELT.....	40
FLOOR DRIVE COMPONENTS – DRIVE ASSEMBLY UP TO JUNE 2023	41
FLOOR DRIVE COMPONENTS – DRIVE ASSEMBLY AFTER JUNE 2023.....	42
SPINNER ASSEMBLY.....	43
REAR DOOR ASSEMBLY – UP TO DECEMBER 2022	45
REAR DOOR ASSEMBLY – FROM DECEMBER 2022	46
AXLE ASSEMBLY	47
HUB ASSEMBLY – ADR	49
GEARBOX DETAILS – RT200	51
GEARBOX DETAILS – RT300	52
ROLL OVER COVER.....	53
TROUBLESHOOTING	55
NOTES	56

Introduction

Thank you for purchasing a Giltrap product. Giltrap Engineering Ltd has enjoyed a long-standing success with their machinery. We would like you to enjoy the benefits of owning a Giltrap too. By following the guidelines laid out in this book, you will ensure trouble free, low maintenance operating for years.

Giltrap Engineering Ltd is a progressive company which continually strives to satisfy your needs, so we welcome any feedback which you can provide to help us improve our products and services and to ensure that they perform to your expectations. Any constructive comments about this operator's manual are also welcome.

Your machine has been designed to perform its task efficiently and with a minimum of maintenance. This handbook provides safety guidelines, instructions, maintenance requirements and parts listings. We recommend that you read the entire handbook, before operating the machine as this will enable you to take full advantage of your new machine's considerable potential.

Delivery

Before you begin to use your machine, please check to make sure there is no delivery damage. If damage is evident, contact the dealer who supplied the machine so that they can make the appropriate claims.

If you have any other queries, please contact your dealer or Giltrap Engineering Ltd (0800 80 GILTRAP).

Please fill in the details below for future reference.

Model:

Serial No:

Delivery Date:

Dealer:

Warranty

The goods specified in the Price List as designed and supplied by Giltrap Engineering Ltd are warranted against faulty workmanship and defective materials for a period of 24 months from the date of purchase. In addition to the primary 24 month warranty for Giltrap products, there is a further 12 month structural warranty for the goods, against faulty workmanship and/or defective materials for structural items only. The structural warranty does not apply to electronics or component parts.

Such warranty is subject to the following conditions:

1. This warranty covers the repair or replacement of parts or machinery sold by the manufacturer and damaged as a result of the faulty workmanship or materials in such parts or machinery. It does not extend to any other loss or damage including consequential loss or damage or loss to other property or persons.
2. Without limiting the generality of paragraph 1 above, this warranty does not cover the following:
 - (a) Travel expenses.
 - (b) Damage caused by accident, misuse or abuse.
 - (c) Damage to any goods which have been altered or modified by someone other than the manufacturer or its authorised agent.
 - (d) Damage or loss to the goods due to their unsuitability for any particular use or for using with any particular tractor except where such use or tractor had been specifically approved by the manufacturer.
 - (e) Damage or loss where the fitting and installation of the goods were not carried out by the manufacturer or its authorised dealer.
3. Procedure for recovery under warranty.

No loss or damage will be covered by this warranty unless the loss or damage is reported immediately to the dealer (who will contact the distributor who will advise whether it is covered by the warranty and undertake the necessary action).

No warranty repair work is to be undertaken prior to an order number being obtained.

This warranty shall be interpreted according to the laws of New Zealand and the parties agree to submit to the jurisdiction of the Courts of New Zealand.

Serial Number Identification

Before ordering any parts, check the serial number of the machine and include this information with all orders.



General Safety

For the safety of others and yourself, please read and follow the precautions in this operator's manual. Pay particular attention to the following safety aspects of operating machinery.

Do not ride on or allow passengers on the machine.



**NO
PASSENGERS**

Always use a recognised hitch pin with a safety clip to hook trailed implements on behind the tractor.

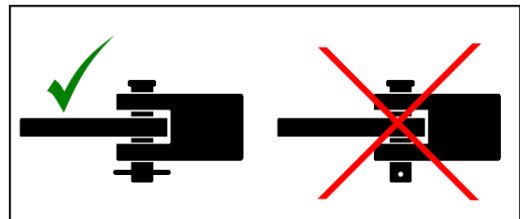

Always ensure when using a quick hitch that the locking tab has come out and is in the locked position before moving.

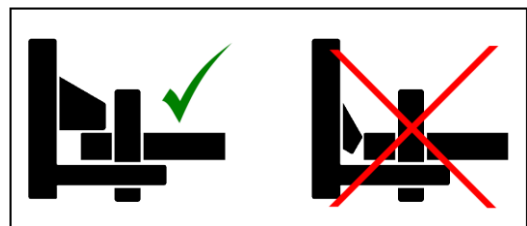

When pulling trailed implements or loads, be sure to use a tractor of greater or equal weight than the combined weight of the load and trailer.

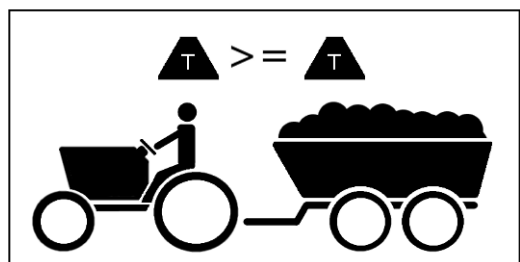

Carry a suitable fire extinguisher.

A fire can ignite under certain conditions, so please take the following precautions:

After running your machine for a short time, check for defective bearings. A faulty bearing can become very hot, eventually discolouring, requiring immediate replacement.

Do not allow combustible material to accumulate inside guards or around rollers and other moving parts.

If your machine becomes blocked, stop immediately and remove the obstruction.



Be careful when operating in hot or dry conditions or on extreme fire risk days.

Never operate your machine without the safety guards in place.



All chains should be properly adjusted and replaced when necessary.

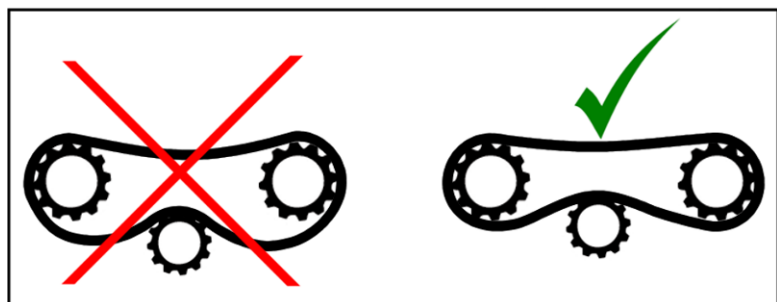

Release all hydraulic pressure from implements before commencing service work. Never look for suspected oil leaks with your hands or body - use a piece of cardboard instead.

Any fluid that penetrates the skin will have to be removed immediately by a medical expert. Seek specialist advice on this type of injury.



Never attempt to unblock equipment while it is still operating.

Always disengage power take-off, hydraulics and shut down engine before removing materials, checking or servicing.

Failure to follow these precautions is likely to result in serious injury.



Wear proper protective clothing. Loose attire can easily be snagged by rotating machinery resulting in serious injury or death.



Pre-Service Guidelines & Settings

Prior to delivering your machine, your dealer should have completed a pre-delivery check. It is required to check the following points before using the machine for the first time.

- CHECK ALL WHEEL NUTS ARE SUFFICIENTLY TIGHT.

Wheel Nut Recommended Torque Settings

M18 - 200 ft/lbs or 270Nm

M20 - 280 ft/lbs or 380Nm

M22 – 330 ft/lbs or 450Nm



- CHECK ALL TYRE PRESSURES ARE CORRECT.

Recommended Tyre Pressures

11.5/80-15.3 58psi 4.0 bar

400/60-15.5 50psi 3.5 bar

15.0/70-18 45psi 3.1 bar

400/55-22.5 46psi 3.2 bar

500/45-22.5 35psi 2.4 bar

500/60-22.5 35psi 2.4 bar

560/45R22.5 58psi 4.0 bar

560/60R22.5 58psi 4.0 bar

650/55R26.5 58psi 4.0 bar



- CHECK ALL AXLE MOUNTING BOLTS AND NUTS ARE SUFFICIENTLY TIGHT.

Axle Mounting Bolt Recommended Torque Settings

M16 - 180 ft/lbs or 245Nm

M20 - 355 ft/lbs or 480Nm



- **THE CONVEYOR BELT MUST** be checked for correct tension, and adjusted if necessary. See page 13 for information on conveyer belt adjustment.
- **THERE ARE SEVERAL GREASE POINTS** on all machines. Check the yellow label on the side of your machine to see how many grease points there are. You should fully grease everything before running it for the first time. See page 14 for lubrication details.
- **CHECK AND RETIGHTEN WHEEL NUTS AFTER:**
 - First use
 - First laden journey
 - The first 50 hours of use and every 50 hours thereafter

Initial Setup

Hydraulic Requirements

The spreader is fitted as standard with two 32cc hydraulic motors running in parallel, requiring an oil flow of 60L/min @ 2500 psi.

For tractors with flows below this amount, it is possible to plumb the motors in a series arrangement. In this setup, 35L/min will suffice.

Two spinner motors running in parallel. This option gives the spinners more torque and runs the spinners at lower pressures but the machine would then only operate with a minimum of 60 l/min flow.

Spinner speed is set and adjusted manually using knob labelled “SPINNER SPEED” on front face of valve block. Winding knob in (clockwise) will decrease spinner speed, winding out will increase spinner speed.

Coupling the Hydraulics

The pressure hose must be coupled to a high pressure outlet port on the tractors external system.

The return hose can be coupled into the same double acting bank using the quick release coupling supplied but can give better performance if plumbed directly back to tank via a large $\frac{3}{4}$ ” or 1” dump connection.

With the tractor at idle, engage the hydraulics. For most common setups, the right hand spinner should rotate clockwise and the left hand spinner run anticlockwise.

If hydraulic flow is reversed, belt may travel in reverse and spinners will not rotate.

Note: Some machines have a reversible spinner circuit fitted so the spinner direction can be reversed if required for bulky material such as mulch or compost.

Power

12V supply is required directly from the tractor’s battery through the supplied fused loom.

Basic Spreader Maintenance

Adjusting the Conveyor Belt

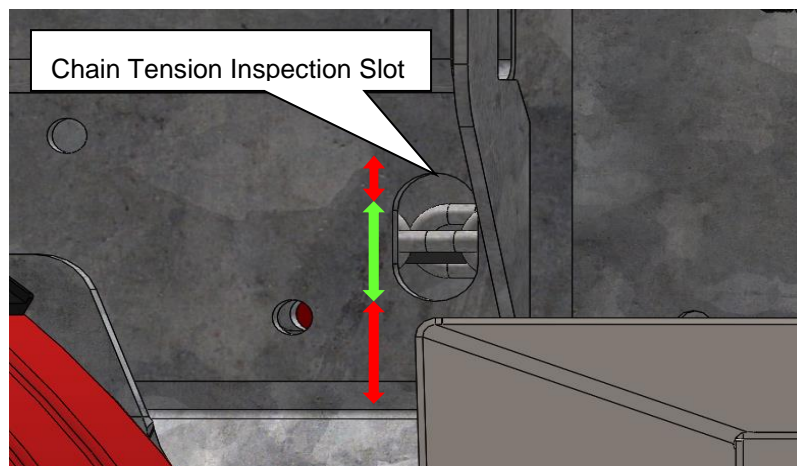
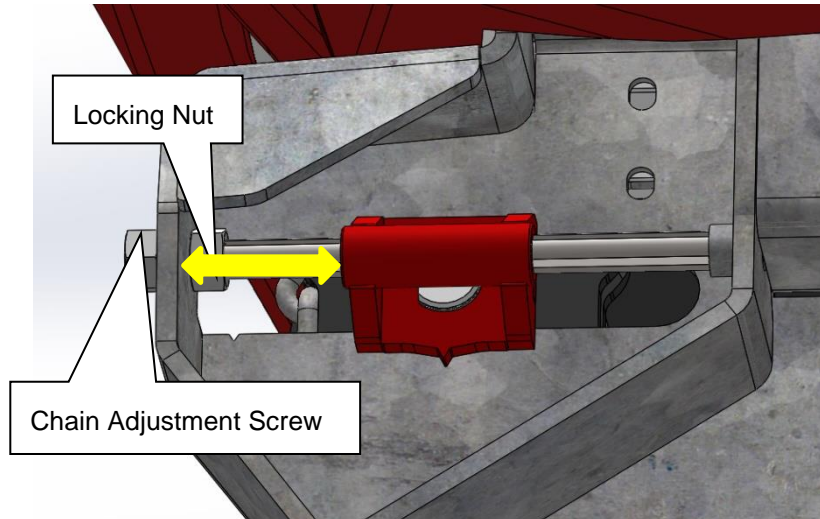

- If the chain is sagging below the inspection slot at rear of machine (**BOTTOM RED ZONE**), loosen locking nut and tighten (turn clockwise) the belt adjustment screw. Recheck chain sag at rear through inspection slot. If chain is below slot cut out, increase tension until chain can be seen through slot (**GREEN ZONE**).
- Do not overtighten, (**TOP RED ZONE**) chain & belt should be able to be move up and down ~30mm when pushed from underneath at inspection slot location.
- Ensure adjusters are evenly tensioned on either side of machine. Measure distance from tensioner to profile (**YELLOW ARROW**) and ensure measurements match on either side.
- CHAIN TENSION MUST BE CHECKED AND READJUSTED AFTER THE FIRST FEW LOADS AS THE CHAIN WILL BED IN. Recheck chain tension weekly.

Greasing the Machine

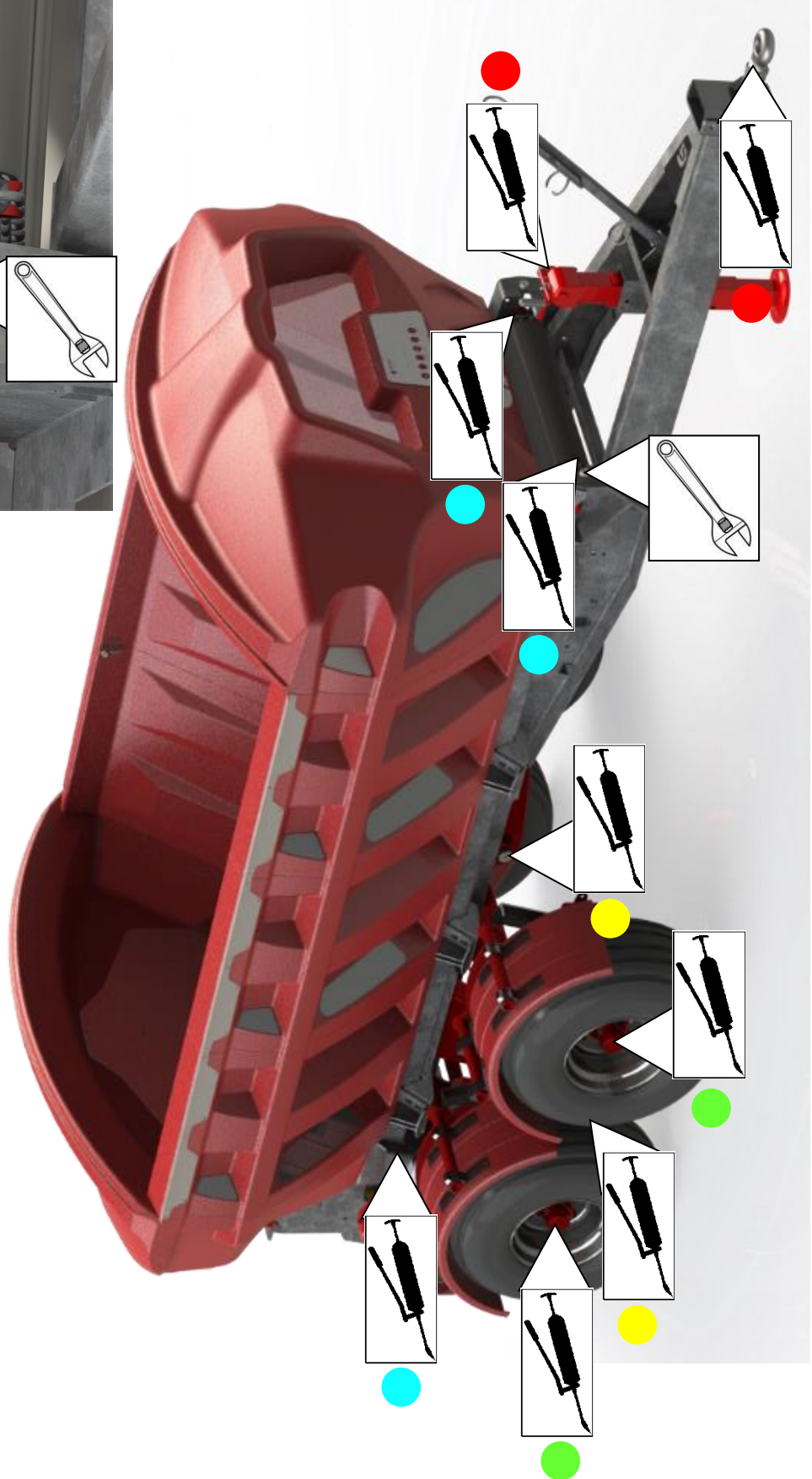
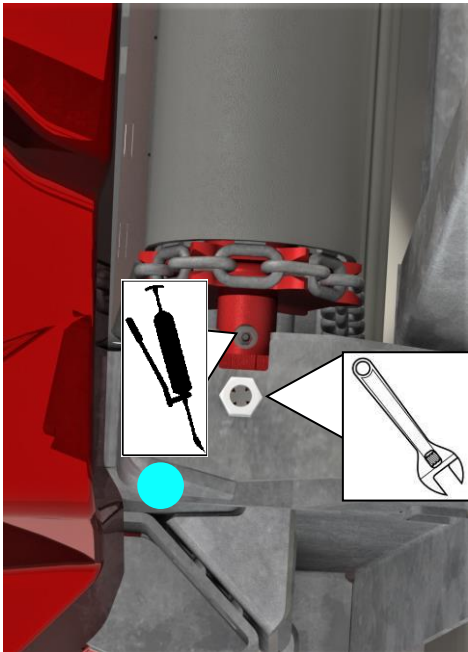

- Axle Bushes (x4)** – 4 pumps every second day
- Wheel Hubs (x4)** – Repack bearings 6 monthly
- Front & Rear Shaft Bushes (x4)** – 1 pump every 2nd day
- Jack Stand & Tow eye (x1)** – 4 pumps weekly

Bulk Densities Rough Guide

Please note these densities are a guide only and for accurate spreading each batch of product should be measured with the provided scales and measuring cup as per the instructions on the following page

PRODUCT	kg / liter
CAN	1.1
DAP	1.1
Dolomite	1.4
Durasul Sulphur	1.35
Granmag	1.1
Lime	1.55
MAP	1.1
Meat and Bone Meal	0.8
Muriate of Potash	1.2
Nitrophoska 12-10-10	1.1
Nitrophoska Blue	1.1
Reactive Rock - Sechura	1.5
Salt	1.2
Serpentine Super	1.25
Sulphate of Ammonia	1.0
Sulphate of Potash	1.1
Sulphur (raw)	1.35
Superphosphate (granular)	1.2
Superphosphate (powder)	1.1
Triple Super	1.15
Urea	0.85

Measuring Bulk Density of Product

Follow the instructions below for the most accurate way of measuring the bulk density of products, this is crucial in order to achieve accurate rates of spreading.



Turn scale on by pressing and holding button marked 

Ensure units are in grams (displayed g), if needed change by pressing the unit button



Place empty cup on scale and then zero scale by pressing button marked 



Fill the cup with product, ensuring it is level with the top



Weigh the product

Divide the weight in grams by 1000 to get the product density.

For example if the cup weighed 1644 grams the density would = 1.64KG/L

A cup weighing 900 grams would = 0.90KG/L

Take 3 samples of product and average them for best results

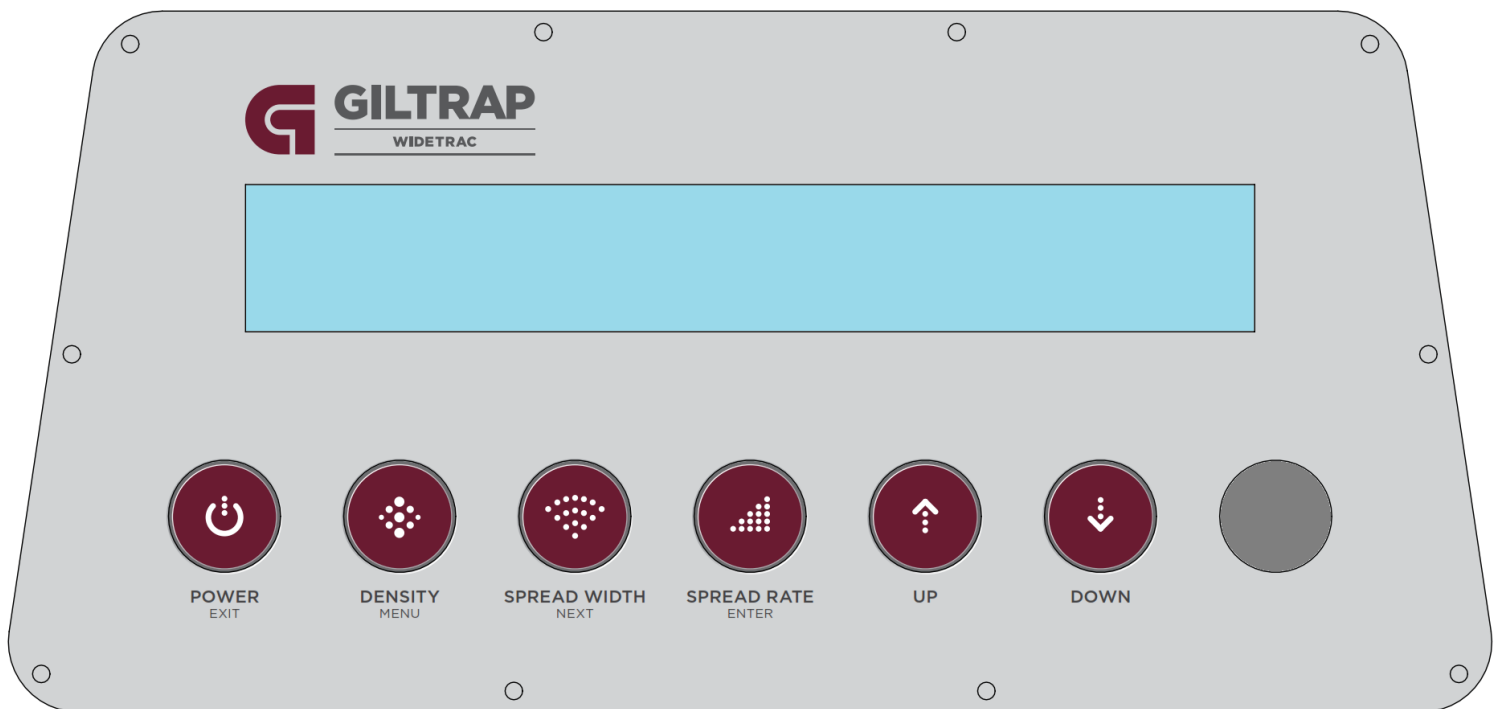

General Operation



On the powered-on standby screen, the 3 main parameters, the spinner speed, and the ideal driving speed range is cycled through on the display. Press button (Density, spread width, or spread rate) to access menu and use arrows to change setting.

Density





Weigh a litre of product to be spread and input weight into density field.

Press  button and use  and  buttons to increase or decrease density value. Units in KG/L.

Spreading Width

Input driving centres. Press  button and use  and  buttons to increase or decrease spread width value. Units in M.

Spread Rate

Input spread rate. Press  button and use  and  buttons to increase or decrease value. Press  button again to cycle through which value to change (1s, 10s, 100s, or 1000s), changing number will be underlined. Units in KG/HA.

Setting Spinner Speed

Set tractor to operating RPM or set flow to at least 60L/min and engage hydraulics. Use adjustment knob on front of valve block to increase or decrease spinner speed. Recommended spinner speed is 950 RPM. Use locking ring to set knob in place. Spinner RPM will show when machine is spreading and in the standby menu.

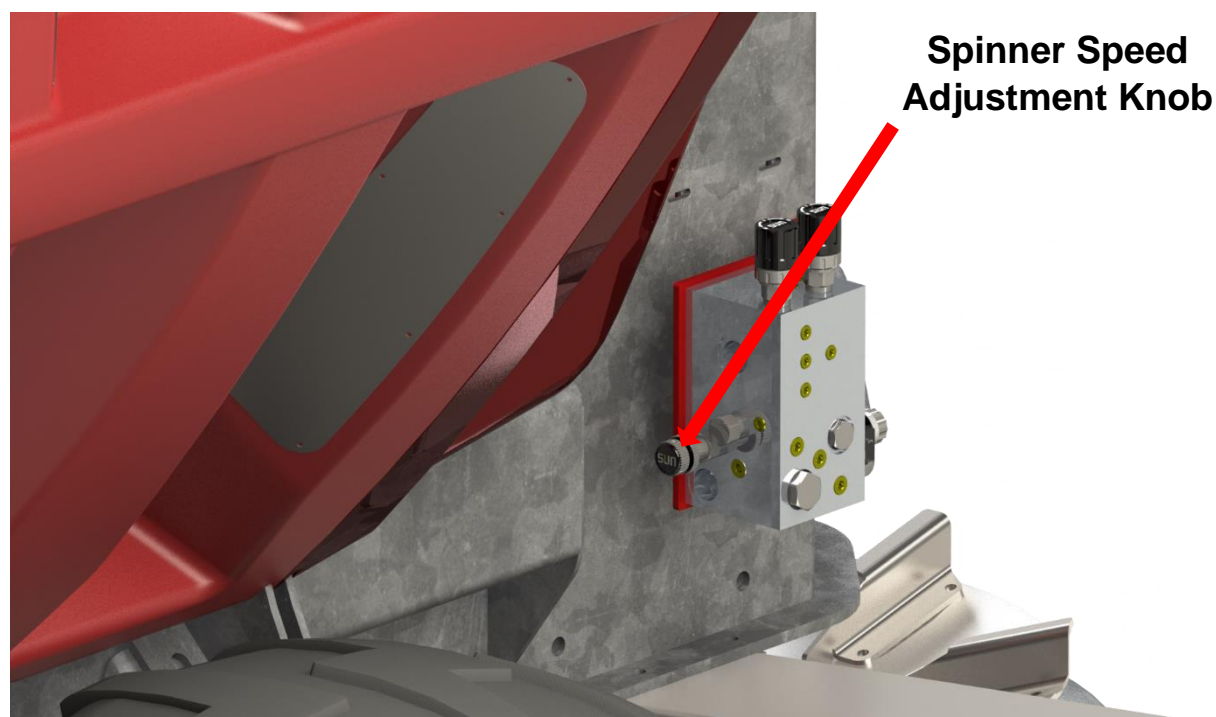

**Spinner Speed
Adjustment Knob**

Spreading Display

When the green button on remote is pressed and the LED on controller is GREEN showing the machine is ready to spread, a ground speed will start the belt and the controller display will change and alternate between showing spinner RPM and ground speed, belt speed and door height.

Machine Setup & Calibration

The controller must be calibrated every time it is used with a different tractor. Calibration finds the belt speeds possible with a tractors available hydraulic flow.

If calibration is not run, the spreader will not have the appropriate available speed range and can cause the machine to spread inaccurately.

With power and hydraulics connected press and hold the  button.
-----MENU----- will be displayed, keep holding button until “1 FINE TUNE %” is shown.

Press  button to move through menu until, “3 BELT CAL”.

Press  to enter menu. Instructions for calibration will be displayed on screen.

During the calibration process, keep away from exposed belt at front of machine as it may begin rotating without notice.

Set tractor engine to operating RPM or set flow to at least 60L/min. Engage hydraulics and then press  on controller.

The controller will find and set values for minimum and maximum belt speeds depending on tractor hydraulic flow available at set RPM.

Wheel size is the diameter (in millimetres) of tyres fitted to spreader – This option is set from factory.

If wheels & tyres are changed, wheel diameter measurement must be checked. Ensure tyres are at correct pressure, park the spreader on flat, level ground and measure the height of the right rear tyre (closest to the floor gearbox). Adjust wheel size setting in menu to match.

LEDs and Warning Messages

- “Slow Down” will be displayed when ground speed is too high. Tractor hydraulic flow cannot drive conveyor fast enough to maintain set spread rate. Decrease ground speed or decrease set spread rate. Normally only shows when the controller is set to very high spread rates and door is already opened to maximum height.
- “Increase Speed” will be displayed when the ground speed is too low. The conveyor cannot be run slow enough to spread required rate at measured ground speed. Increase ground speed or increase set spread rate. Normally only shows when the controller is set to very low spread rates.
- “Door Opening” will be displayed when the door is moving to the start-up position
- “Door Closing” will be displayed when door is closing. When powering off.
- “RED” LED on when the door is opening to start-up position (not ready to spread)
- “GREEN” LED on when machine is spreading normally or is ready to spread.
- “BLUE” LED on when door is closing
- “YELLOW” LED on when machine operating outside optimal range. Usually shown with “speed up” or “slow down” message.
- “DOOR TUNING ERROR” shown when door tuning setting is not possible. Adjust setting down or turn off.
- “ACTUATOR ERROR” shown when there is a power or control fault in the door actuator

Remote Control Key Fob

The spreader remote is used to power off & on and start & stop spreading from the tractor cab.

Press the **(ON/SPREAD)** button to power on the spreader controller.

If spreading parameters (product density, spread width, and spread rate) are already correct, press the **(ON/SPREAD)** button to start spreading.

The controller will not start the belt until a ground speed is detected.

If the door is closed and the top button is pressed to start spreading, the LED will be RED while the door moves into position and the “Door Opening” message will show on-screen. The LEDs will turn GREEN and screen will say “Ready to Spread” once door moves to correct height.

To stop spreading, press the bottom **(OFF/PAUSE)** button. This will stop the belt moving and door will remain at the height it was when button was pressed.

To power off and close the spreader door, press and hold the **(OFF/PAUSE)** button until the screen says “DOOR CLOSING”.

The remote uses 1 X 12V A23 battery. When replacing the battery, mind the plastic tab on the battery cover as it can catch and move the DIP switches.

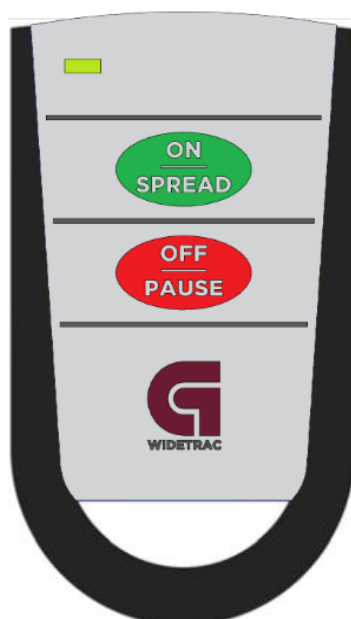

Setting Remote Control DIP Switches

Remote controls are set as standard to control all WideTrac fert spreaders. If 2 or more spreaders are to be used in close proximity it may be necessary to set the spreaders on different channels.

To change DIP switch settings on the remote, remove the battery cover on rear of remote and adjust position of switches.



To change DIP switch setting on controller, remove screws holding controller to front panel. Clean front panel around controller before removing to ensure no dirt can fall onto the controller circuit board. DIP switches are located on the receiver with the white coiled antenna.

Match the controller DIP settings with the remote DIP settings.

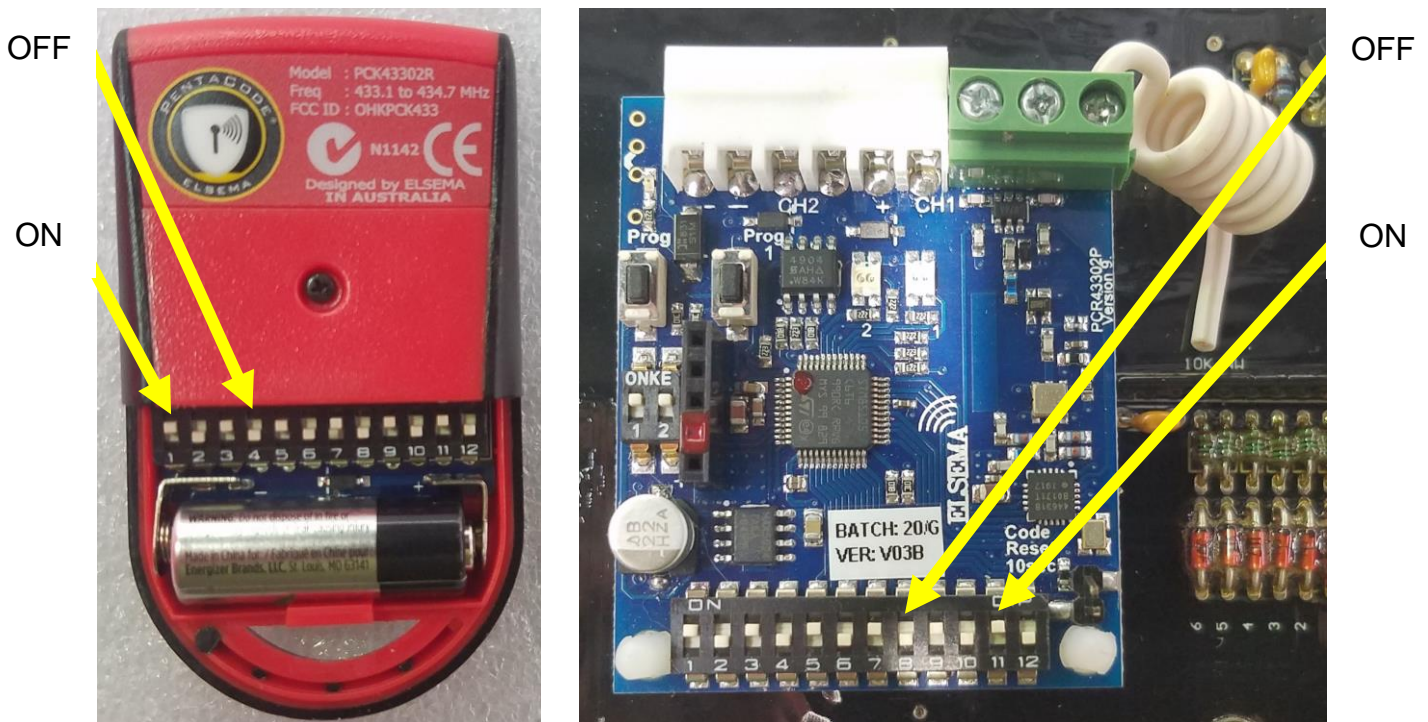
Note: Remote will not operate if all switches are in OFF position, down closest to battery.



Fine Tune Setting

The Fine Tune Setting adjusts the belt speed to compensate for how different types of product flow through the spreader's door. This setting can be adjusted if the operator finds the machine is spreading too heavy or too light. The fine tune setting can be accessed in the Main Menu, by pressing and holding the  button and using the  button to scroll to Option 1: Fine Tune %.

Press  button to enter the Fine Tune Menu.

Fine Tune setting can also be accessed in the main standby screen by pressing and holding .

If loaded product weight and coverage area are known, fine tune settings can be adjusted more accurately.

For example, if a bin load is 6000kg and is to be spread at 300kg/Ha, it should cover 20Ha. If the bin empties before the 20Ha, the machine is spreading too heavy and the fine tune setting should be decreased. If there is still product left in the bin after covering 20Ha, the machine is spreading too light and the fine tune setting should be increased.



The amount of fine tune adjustment required depends on the amount of product left in the bin after spreading known area (light) or known area left to spread once bin has emptied (heavy). If the machine is spreading 10% too heavy or too light, the fine tune setting should be adjusted by 10%.

Door Tuning

If after adjusting the fine tune settings, spreading is still inconsistent, the 'ideal speed' setting can be adjusted. Always adjust "Fine Tune" before adjusting "Door Tuning".

The door tuning setting can be adjusted to suit spreading on undulating ground. Where the spreader may be climbing steep hills at a slower speed. In these situations, the machine may spread heavier due to product flowing through door faster than the belt is travelling.

Adjusting the door tuning setting down means a higher belt speed is used. This will run the door at a lower height, restricting uncontrolled product movement.

The 'Door Tuning' setting can be accessed in the Main Menu, by pressing and holding the  button and using the  button to scroll to Option 2: Door Tuning.

Press  button to enter the Door Tuning Menu.

Door Tuning setting can also be accessed in the main standby screen by pressing and holding .

Once door tune is set and the controller cannot run selected setting, DOOR TUNE ERROR will be displayed.

Adjust setting and retry. Standard setting is 10.

This setting is only effective when the door is not at the limit of being fully closed or fully open. If spreading at low rates and door is already at lowest height or if spreading at high rates and door is already at max height, this setting should not be changed

Decrease setting to Zero/OFF to switch off.

Manual Movement of Actuator/Door

The electric door actuator can be moved in the “TEST GATE” menu if the machine is powered or manually if the machine is not.

To move the door using the TEST GATE menu, connect power to the machine and switch on the controller. Press and hold the  button and using the  button to scroll to option 5, TEST GATE.

Press the  button to enter the TEST GATE menu

Press and hold the  or buttons  to adjust the door height. Door height in mm is shown on screen.

If the machine cannot be powered, the actuator can be moved manually using a 6mm hex key on the top actuator screw accessible from the inside of the bin.



To access the screw, remove the small stainless cover on the top of the rear panel on the inside of the bin.

Peel back the sticker from the top of the actuator and remove cover bolt using a 6mm Hex key.



Insert the same 6mm hex key into the socket and rotate to move the actuator shaft. Turning the socket clockwise will retract the actuator shaft and counter-clockwise will extend the shaft.

Manual Movement of Floor

The floor can be moved in the “TEST BELT” menu if the controller is powered and machine is connected to a tractor.

To move the floor using the TEST BELT menu, connect power to the machine and switch on the controller. Engage hydraulics. Press and hold the  button and use the  button to scroll to option 4, TEST BELT.

Press the  button to enter the TEST BELT menu

Press and hold the  button to increase belt speed. Press and hold the  button to decrease belt speed. Exit menu or decrease PWM% setting to zero to stop belt. Menu will automatically exit and belt will stop after 30 seconds of no setting change.

If the controller is switched off or cannot be powered, the belt can be driven using the manual override knob on the rear of the valve located on the right side of the spinner assembly. Connect hydraulics and engage. Wind in manual override knob until belt moves. Wind knob back out to slow and stop belt.

**IMPORTANT NOTE: MANUAL OVERRIDE KNOB MUST BE WOUND
ALL THE WAY OUT FOR NORMAL MACHINE OPERATION**

GPS Mapping Switch

The controller on the Widetrac has an output for triggering an external GPS mapping switch. The output is connected to a relay that is switched when the spreader's belt is run. The output can be configured so that when the belt is running, the switch is either open or closed. This circuit is only a switched open/close circuit, there is no voltage supplied across any connectors.

On machines manufactured before April 2022 the output connector on the rear of the controller is not wired. Customers/dealers wanting to wire the connectors to switch an external GPS will need to remove the controller and wire the connector.

There are 3 points on the connector, C (Common), NO (Normally Open), and NC (Normally Closed). Only 2 wires are required to use the switch. One must be connected to C (Common) and the other on either NC or NO.

On machines manufactured after April 2022, the connector is wired from factory and the loom is terminated in the power supply loom by the Anderson Plug. The GPS switch wires need to be pulled from the power loom/split loom and be wired to a plug.

The 3 wires in the cable are connected to the 3 points of the relay. Black is C (common), White is NC (Normally Closed), Yellow is NO (Normally Open). Only 2 wires are required to use the switch. One must be connected to C (Common) and the other on either NC or NO.

When connected to C and NC, the circuit will be closed when the belt is not moving.

When connected to C and NO, the circuit will be open when the belt is not moving.

Plumbing Diagram

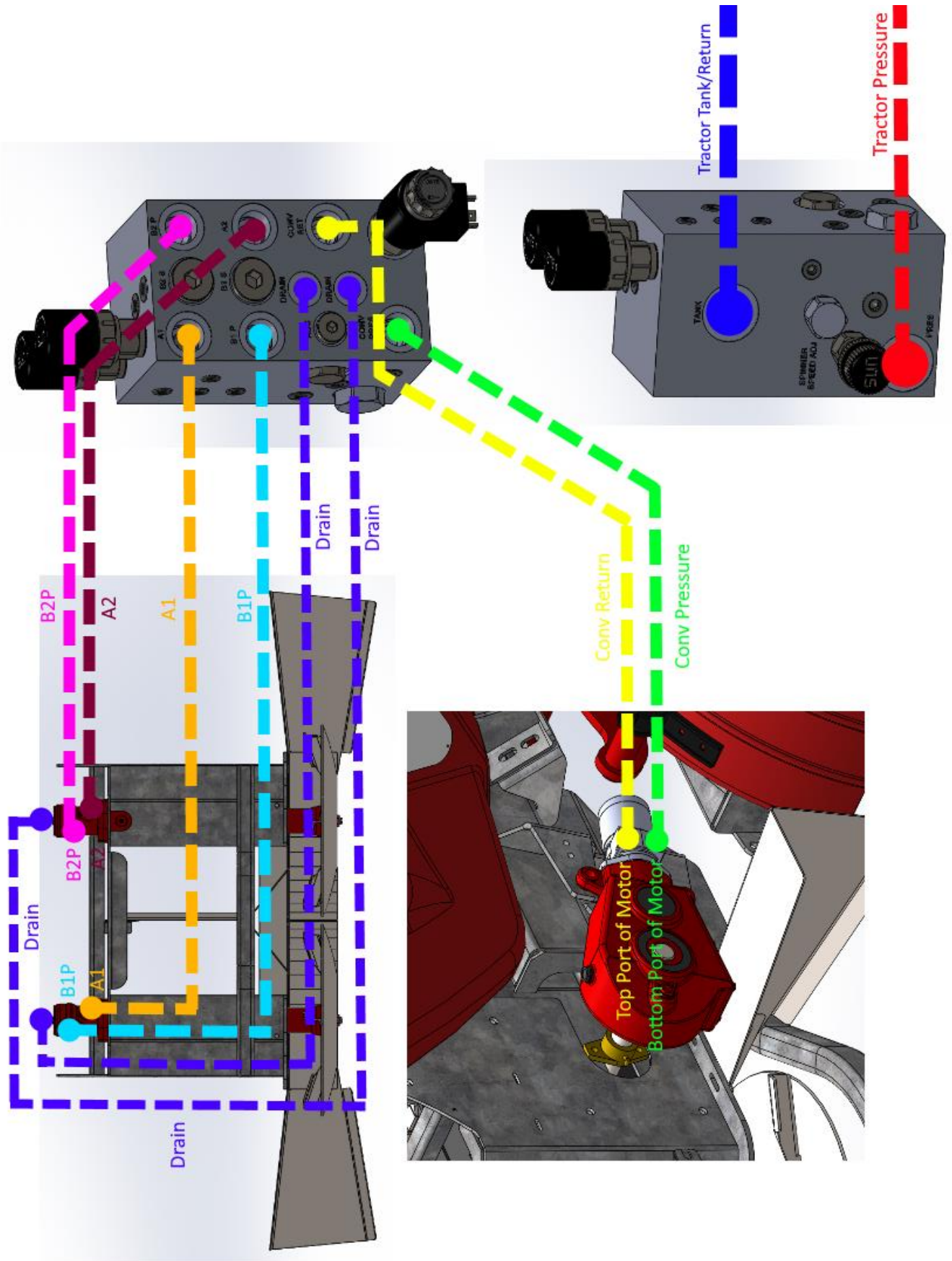

Parts Book Section

TRANSFERS & LABELS	30
ELECTRONIC COMPONENTS	31
HYHCV3484-1 (STANDARD)	33
HYHCV3484 (OPTIONAL SPINNER REVERSE)	34
RETURN LINE CHECK VALVE	35
BIN & PANELS	36
FLOOR DRIVE COMPONENTS – IDLER ASSEMBLY AND BELT	40
FLOOR DRIVE COMPONENTS – DRIVE ASSEMBLY UP TO JUNE 2023	41
FLOOR DRIVE COMPONENTS – DRIVE ASSEMBLY AFTER JUNE 2023	42
SPINNER ASSEMBLY	43
REAR DOOR ASSEMBLY – UP TO DECEMBER 2022	45
REAR DOOR ASSEMBLY – FROM DECEMBER 2022	46
AXLE ASSEMBLY	47
HUB ASSEMBLY – ADR	49
GEARBOX DETAILS – RT200	51
GEARBOX DETAILS – RT300	52
ROLL OVER COVER	53

Transfers & Labels

Part Number	Description	Quantity
13700	QR Code for WideTrac Manual	1
995-1025	Label 'CAUTION! Ensure Hydraulic...'	1
995-1204	Label 'Rear Operators Manual'	1
995-1207	Label 'Moving Parts'	2
995-1221	Label 'Stand well clear...'	2
995-1223	Label 'This machine has...'	1
995-1228	Label 'Ensure jack is in...'	1
995-1240	Label 'DANGER'	4
995-1245	Label Grease Gun	6

Electronic Components

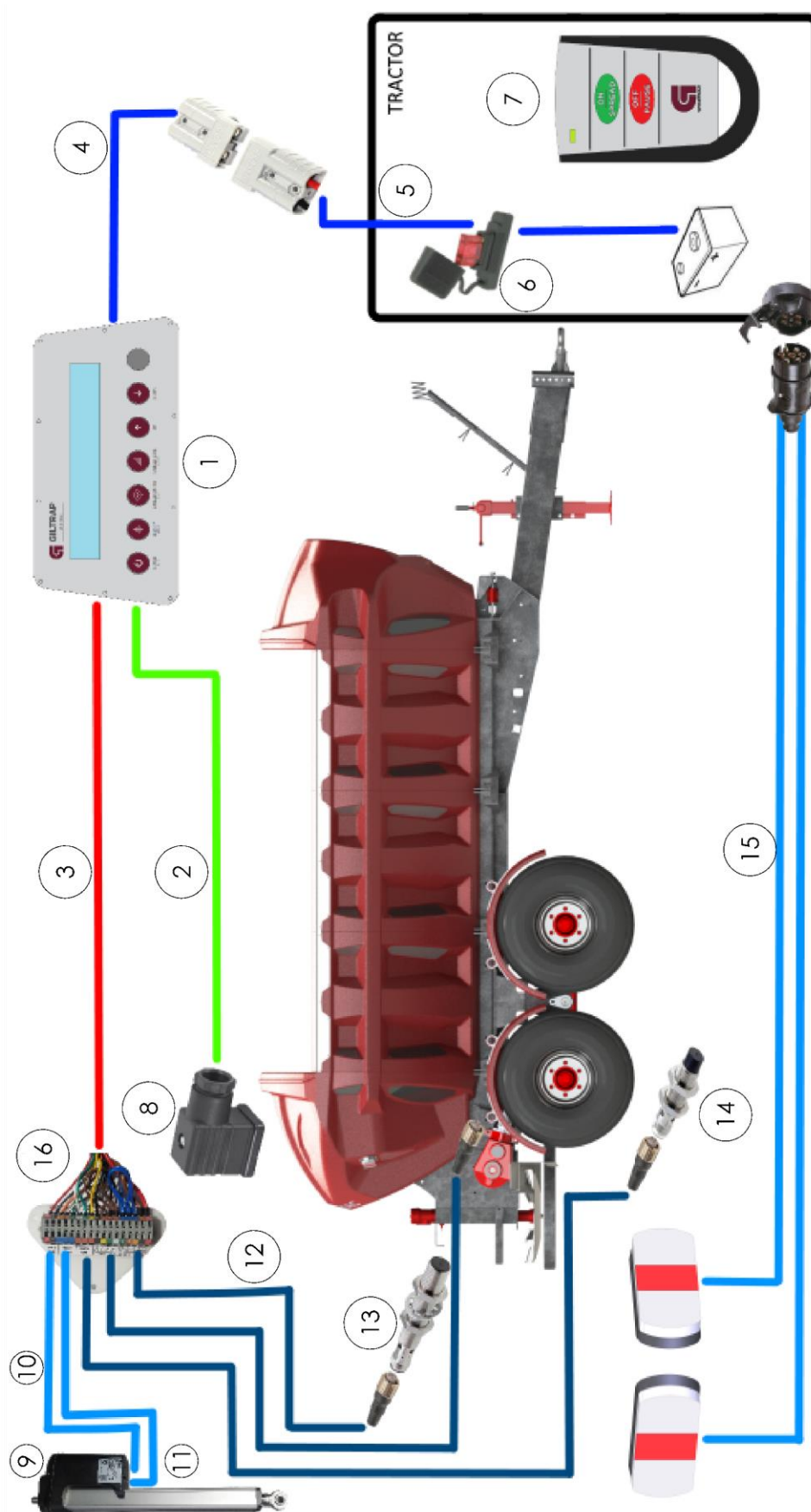

Item	Part Number	Description	Quantity		
			4T	6T	8T
1	13557	WideTrac Controller	1	1	1
2	13661	Floor Coil Signal Loom c/w DIN Plug, 4T	1	-	-
2	13662	Floor Coil Signal Loom c/w DIN Plug, 6T	-	1	-
2	13663	Floor Coil Signal Loom c/w DIN Plug, 8T	-	-	1
3	13664	Main Spreader Loom c/w Termination Board, 4T	1	-	-
3	13665	Main Spreader Loom c/w Termination Board, 6T	-	1	-
3	13666	Main Spreader Loom c/w Termination Board, 8T	-	-	1
4	13667	Spreader Power Loom	1	1	1
5	13668	Tractor Power Loom w/Fuse Holder	1	1	1
6	13669	Fuse, Maxi 30A	1	1	1
7	13660	WideTrac Controller Remote	1	1	1
8	11695	DIN Coil Plug	1	1	1
9	RAM-J14252	Door Actuator, WideTrac Fert	1	1	1
10	RAM-J14252/POWCAB	Actuator Power Cable, WideTrac Fert	1	1	1
11	RAM-J14252/SIGCAB	Actuator Signal Cable, WideTrac Fert	1	1	1
12	12360	Sensor Cable, 5m Straight Plug	3	3	3
13	11654	Proximity Sensor, Spinner	1	1	1
14	11652	Proximity Sensor, Wheel	1	1	1
15	LIGHTKIT	LED Light Kit c/w 9m Lead	1	1	1
16	13871	Termination Board c/w connectors & labels	1	1	1

Termination board of Item #3 located on rear panel, behind stainless panel, under RH light

HYHCV3484-1 (Standard)

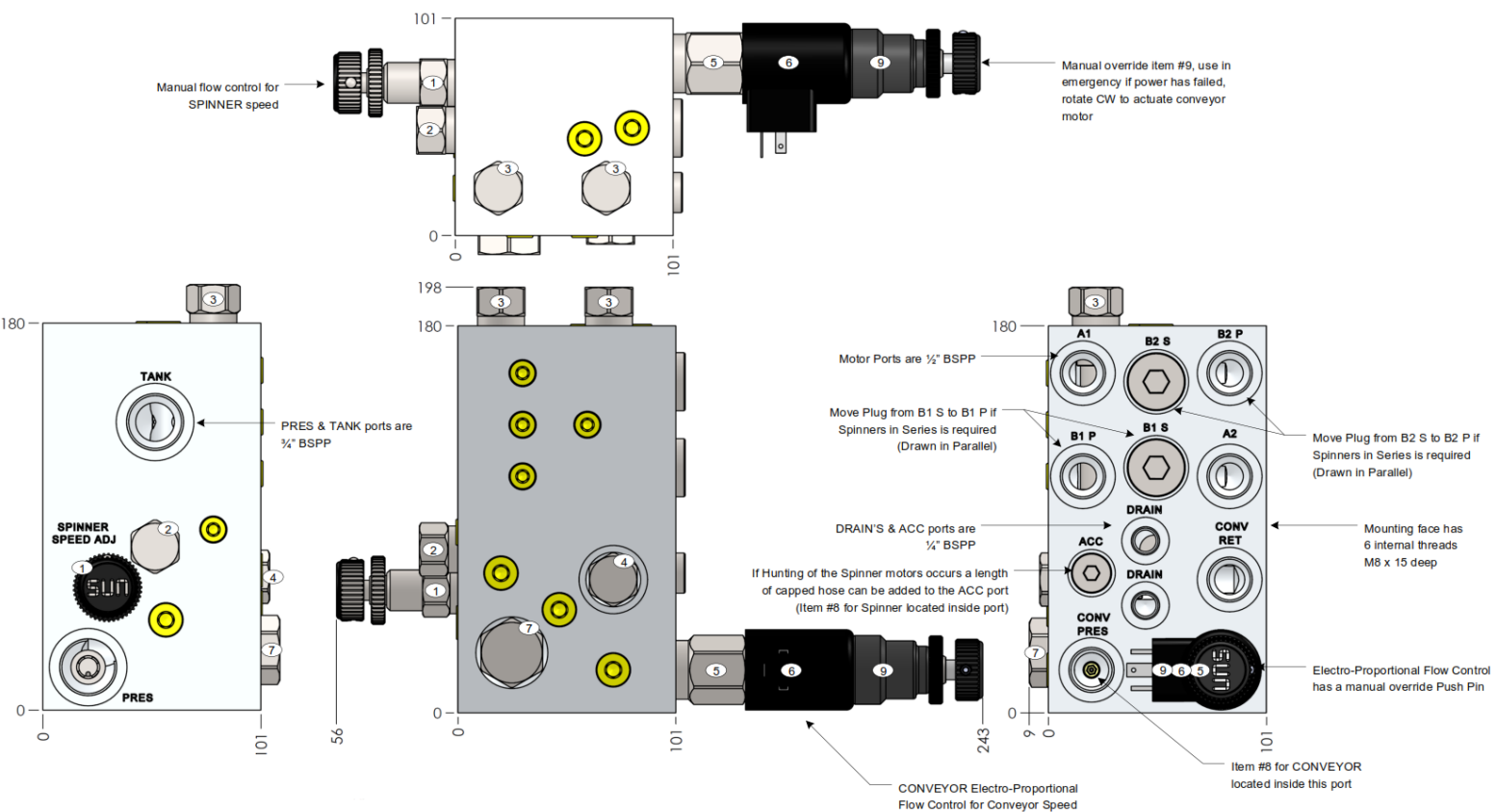

Item	Part Number	Description	Quantity	Setting
1	NFCD KFN	Spinner Speed Control Knob	1	0-8.4mm
2	CXDA XAN	Spinner Overrun Check	1	-
3	XRCA XXN-2	Cavity Blank	2	-
4	LRDC XHN	Spinner Bypass Compensator	1	200psi
5	FPFK MDN	Conveyor Proportional Flow Control	1	0-80L/Min
6	770 212	12VDC Coil (DIN Style)	1	-
7	LRFC XGN	Conveyor Bypass Compensator	1	150psi
8	1/16" X 0.44	Pilot Sensing Orifice	2	0.44mm
9	HCV2521 + Knob	Manual Override Kit	1	

* Under normal operating conditions, the manual override knob (9) must be wound out completely *

HYHCV3484 (Optional Spinner Reverse)

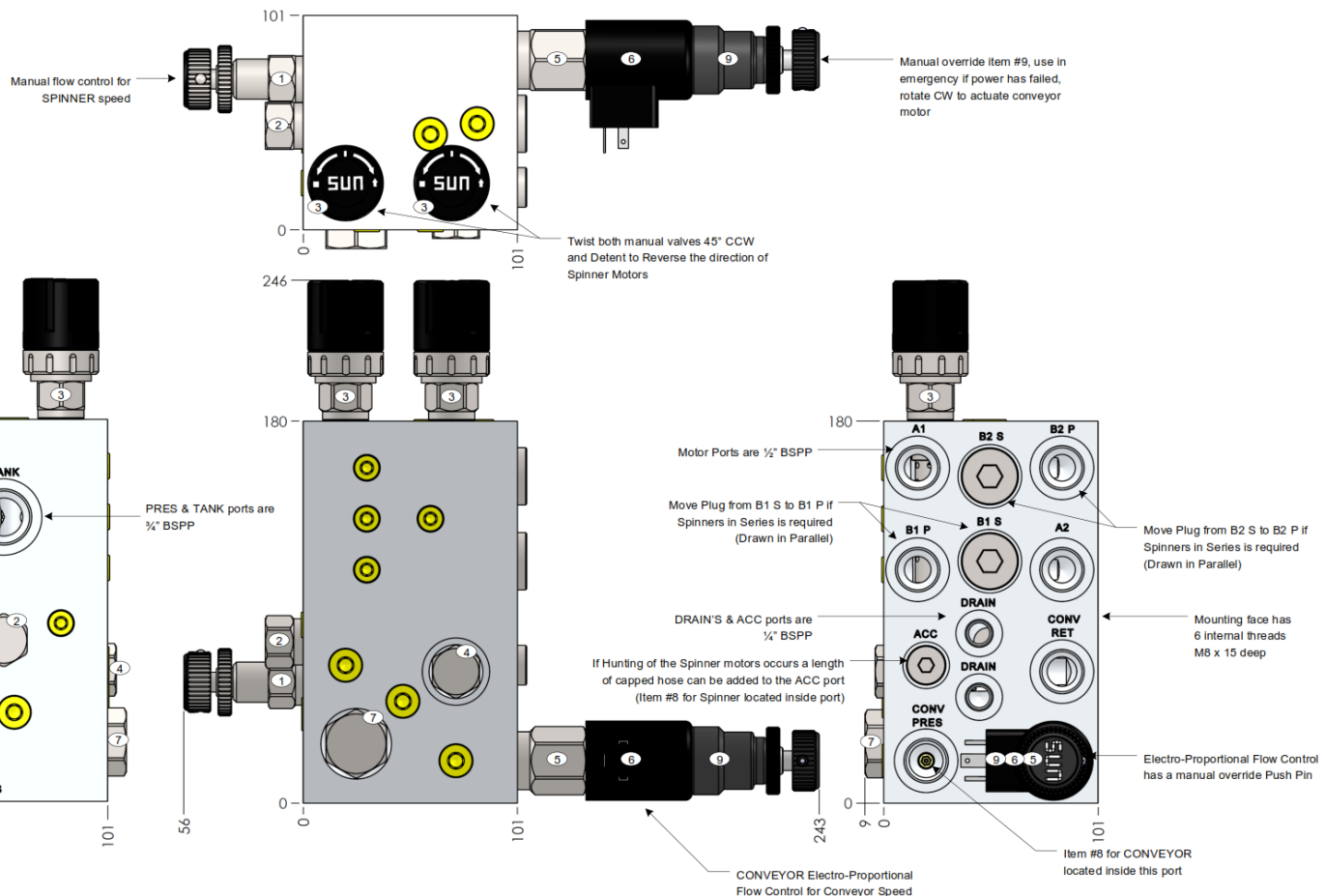

Item	Part Number	Description	Quantity	Setting
1	NFCD KFN	Spinner Speed Control Knob	1	0-8.4mm
2	CXDA XAN	Spinner Overrun Check	1	-
3	DNDM DNN	Spinner Reverse Function (Manual)	2	-
4	LRDC XHN	Spinner Bypass Compensator	1	200psi
5	FPFK MDN	Conveyor Proportional Flow Control	1	0-80L/Min
6	770 212	12VDC Coil (DIN Style)	1	-
7	LRFC XGN	Conveyor Bypass Compensator	1	150psi
8	1/16" X 0.44	Pilot Sensing Orifice	2	0.44mm
9	HCV2521 + Knob	Manual Override Kit	1	

UNDER NORMAL OPERATING CONDITIONS, THE MANUAL OVERRIDE KNOB (9) MUST BE WOUND OUT COMPLETELY

Return Line Check Valve

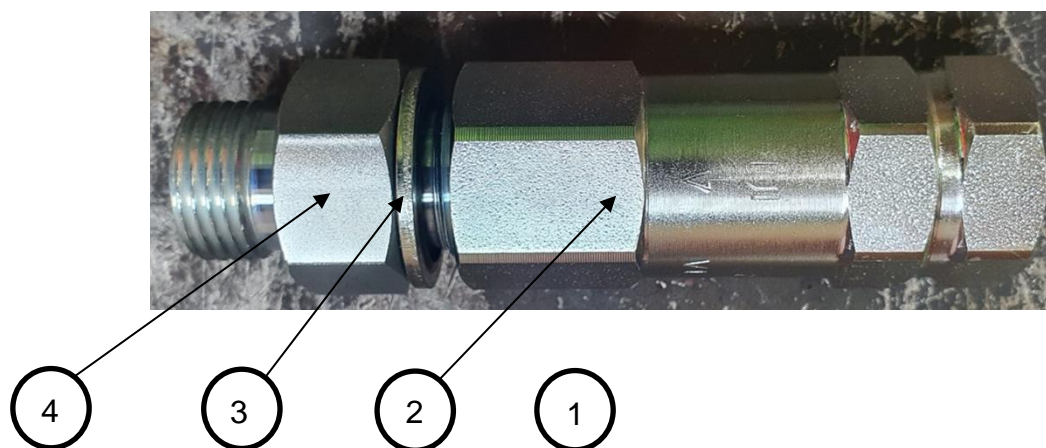

Item	Part Number	Description	Quantity
1	14147	Return Line Check Valve Kit – Complete	1
2	HYFCVF-08	1/2" BSP Ch / Valve Female Thread	1
3	HYFD-08	Hyd Fitting, Dowty Seal, 1/2"	1
4	HYFB-B-0808	Hyd Fitting, Nipple, 1/2" BSPPM x 1/2" BSPPM	1

Return line QRC is fitted to 1/2" BSPPM Nipple and 1/2" BSPPM - 3/4" BSPPM is fitted to inlet end of check valve. Can be removed if plumbing return line directly to tank.

THE RETURN LINE CHECK VALVE **MUST BE FITTED IF MACHINE IS PLUMBED INTO DOUBLE ACTING REMOTES**

Bin & Panels

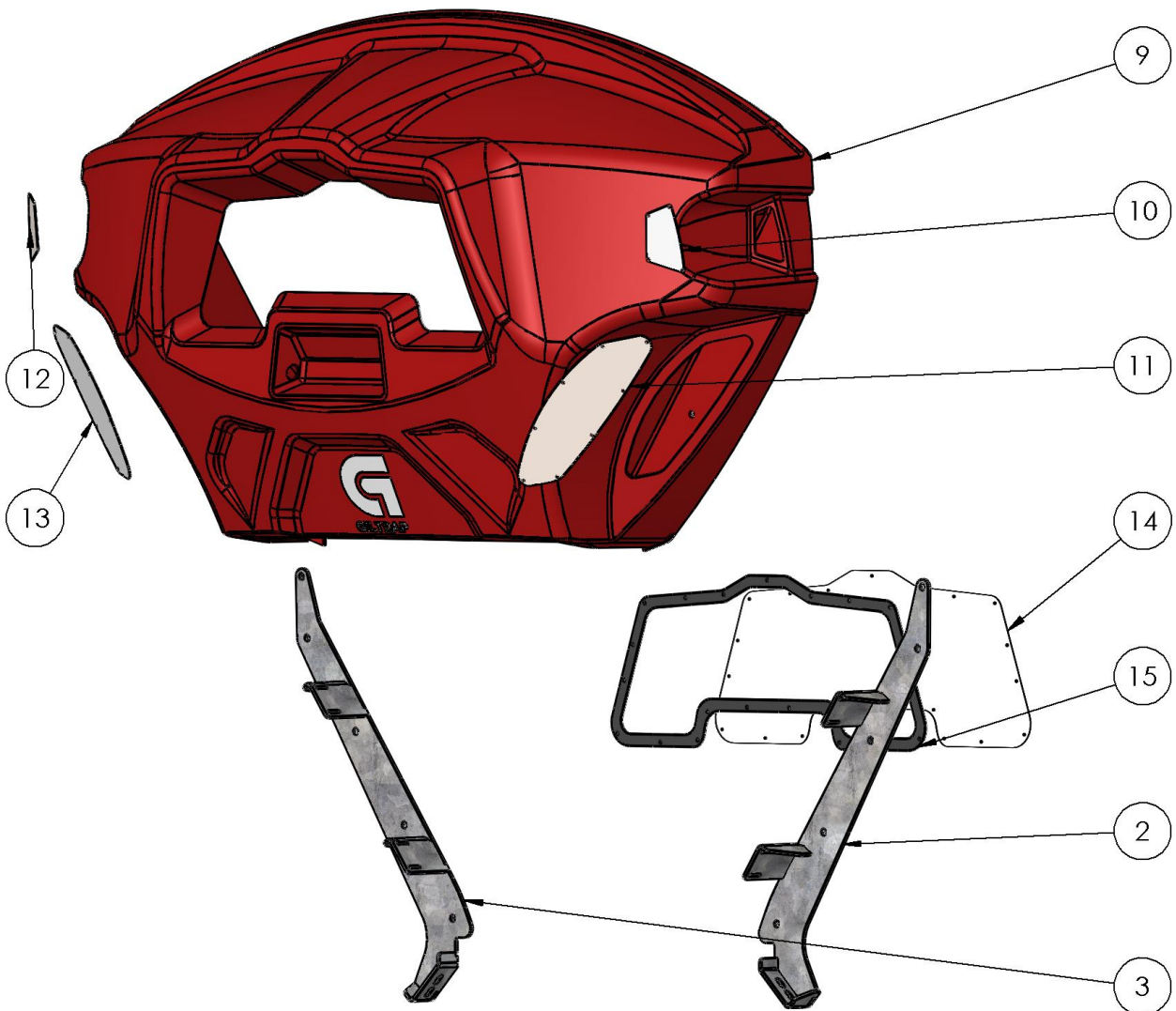
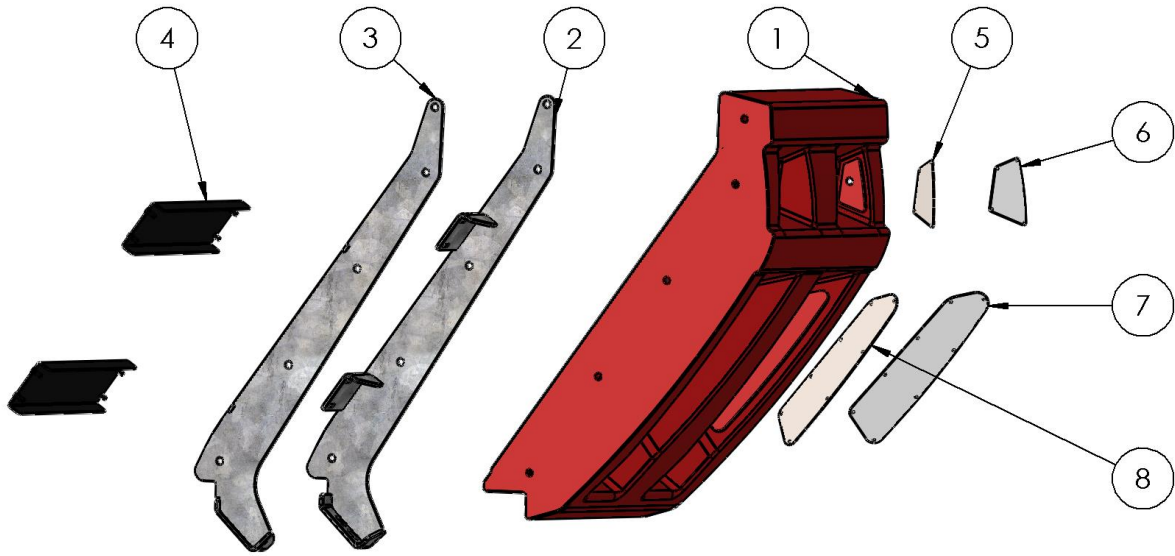

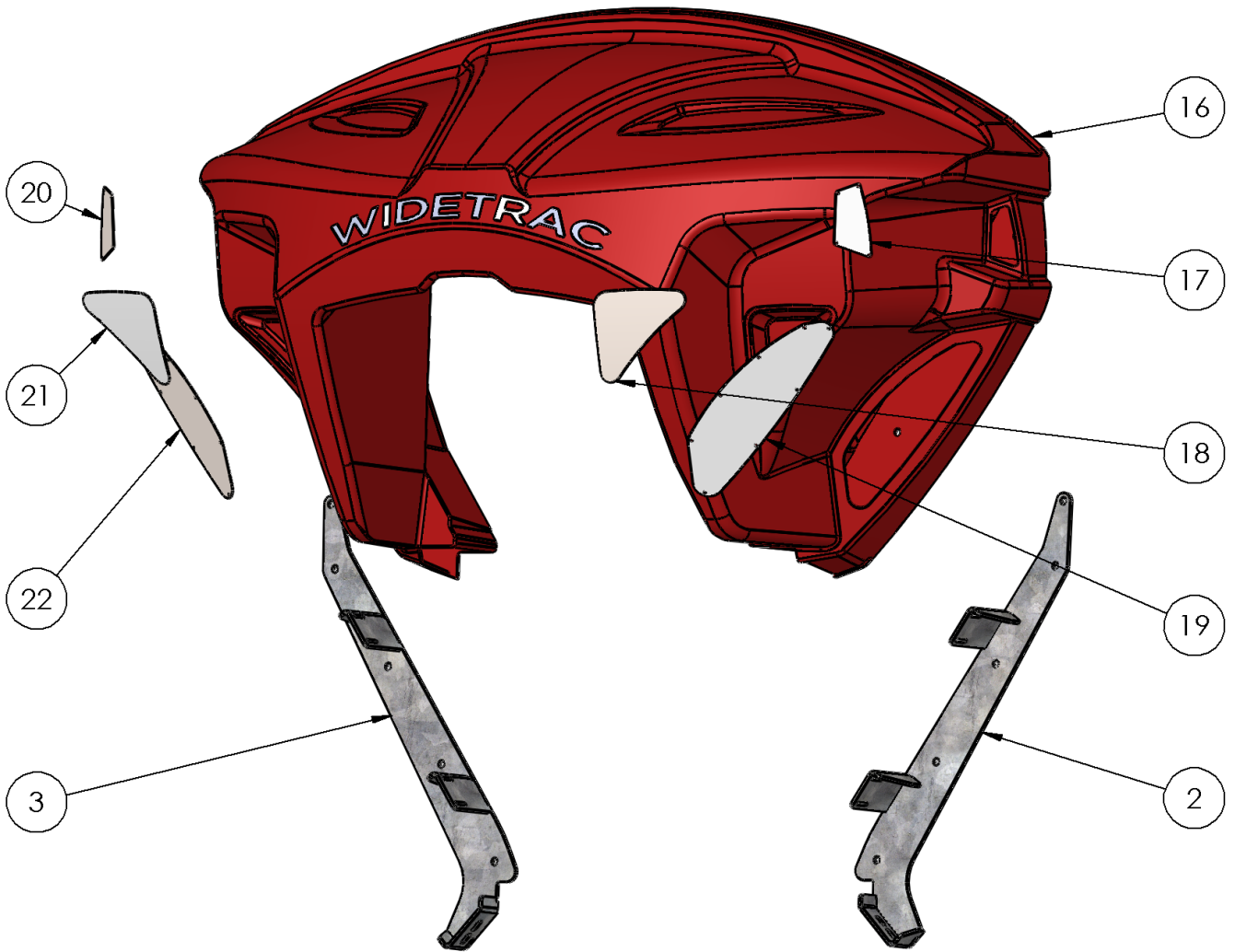

Internal Bin Deflectors

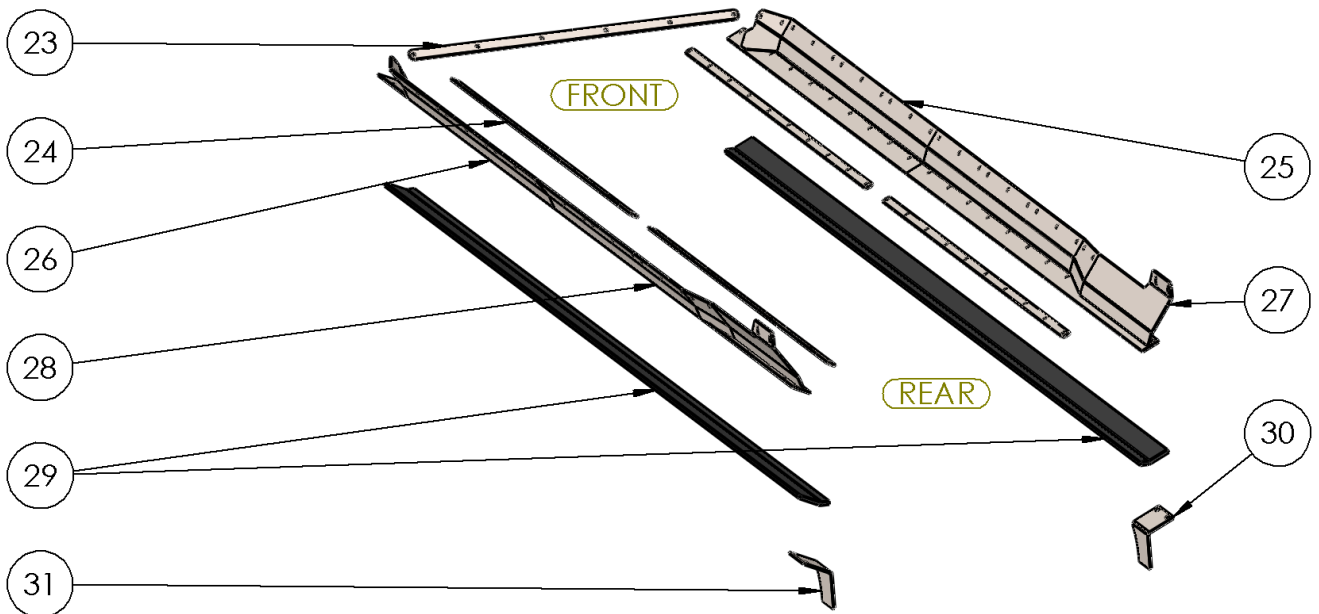

Item	Part Number	Description	Quantity		
			4T	6T	8T
1	13000	WideTrac Side Panel	4	6	8
2	13044-LH	Side Mount, LH	6	8	10
2*	13885-LH	Side Mount, LH	6	8	10
3	13044-RH	Side Mount, RH	6	8	10
3*	13885-RH	Side Mount, RH	6	8	10
4	13045	Support X-Member	8	12	16
5	13046	Side Panel Top Cover, LH	4	6	8
6	13581	Side Panel Top Cover, RH	4	6	8
7	13583	Side Panel Bottom Cover, RH	4	6	8
8	13408	Side Panel Bottom Cover, LH	4	6	8
9	12999	WideTrac Front Panel	1	1	1
10	13584	Front Panel Top Cover, RH	1	1	1
11	13054	Front Panel Bottom Cover, RH	1	1	1
12	13051	Front Panel Top Cover, LH	1	1	1
13	13587	Front Panel Bottom Cover, LH	1	1	1
14	13497	WideTrac Perspex Window	1	1	1
15	13589	WideTrac Window Gasket	1	1	1
16	13001	WideTrac Rear Panel	1	1	1
17	13585	Rear Panel Top Cover, RH	1	1	1
18	13053	Rear Panel Cavity Cover, RH	1	1	1
19	13582	Rear Panel Bottom Cover, RH	1	1	1
20	13052	Rear Panel Top Cover, LH	1	1	1
21	13586	Rear Panel Cavity Cover, LH	1	1	1

22	13047	Rear Panel Bottom Cover, LH	1	1	1
23	13081-1	Front Seal Clamp	1	1	1
24	13409-1	Seal Strip Retainer, 4T	2	-	-
24	13081-2	Seal Strip Retainer, 6T	-	4	-
24	13443-5	Seal Strip Retainer, 8T	-	-	4
25	13710-RH	Front Seal Mount, 4T, RH	1	-	-
25	13057-RH	Front Seal Mount, 6T, RH	-	1	-
25	13707-RH	Front Seal Mount, 8T, RH	-	-	1
26	13710-LH	Front Seal Mount, 4T, LH	1	-	-
26	13057-LH	Front Seal Mount, 6T, LH	-	1	-
26	13707-LH	Front Seal Mount, 8T, LH	-	-	1
27	13709-RH	Rear Seal Mount, 4T, RH	1	-	-
27	13058-RH	Rear Seal Mount, 6T, RH	-	1	-
27	13708-RH	Rear Seal Mount, 8T, RH	-	-	1
28	13709-LH	Rear Seal Mount, 4T, LH	1	-	-
28	13058-LH	Rear Seal Mount, 6T, LH	-	1	-
28	13708-LH	Rear Seal Mount, 8T, LH	-	-	1
29	13782	Rubber Seal Strip, 4T	2	-	-
29	13783	Rubber Seal Strip, 6T	-	2	-
29	13784	Rubber Seal Strip, 8T	-	-	2
30	13036-4-RH	Rear Deflector, RH	1	1	1
31	13036-4-LH	Rear Deflector, LH	1	1	1

*13885-LH & 13885-RH have 4 bolt holes rather than 5 like 13044-LH and 13044-RH.
 Fitted to machines manufactured after November 2021

Floor Drive Components – Idler Assembly and Belt

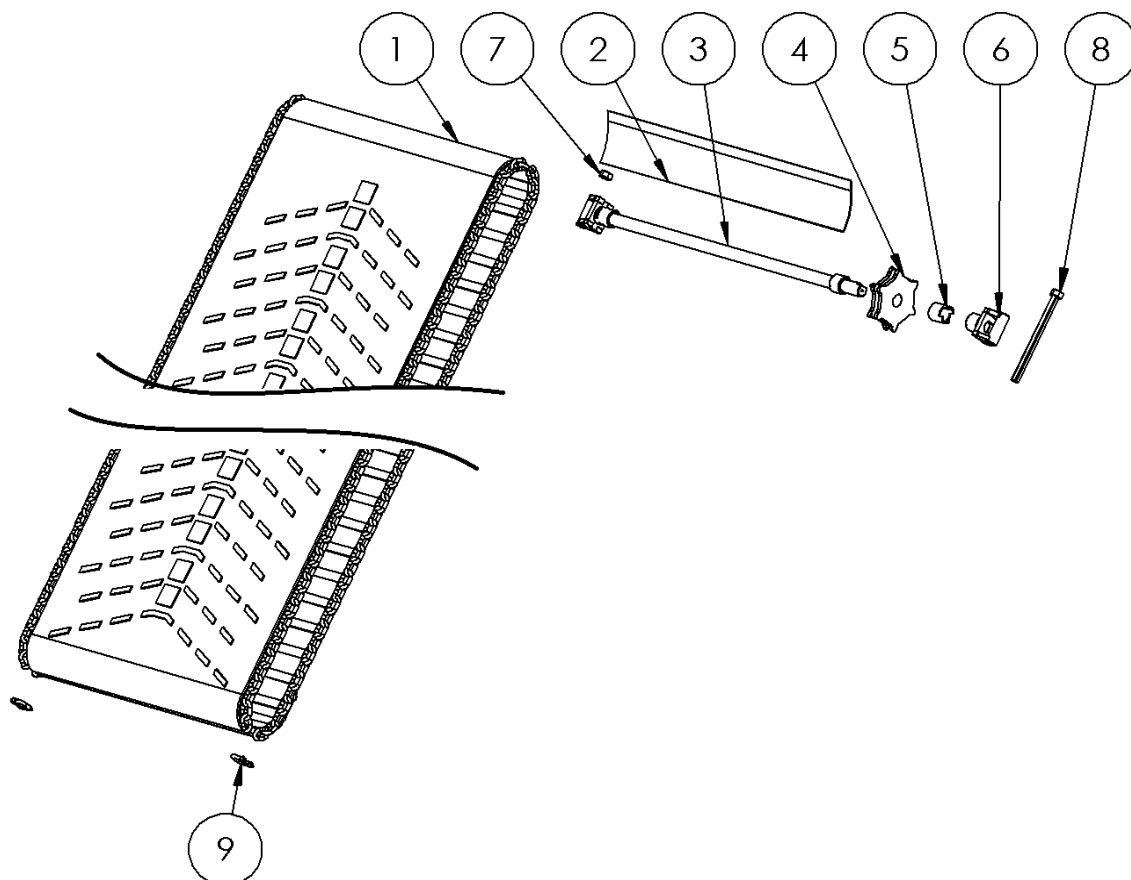

Item	Part Number	Description	Quantity		
			4T	6T	8T
1	13410	WideTrac Chain & Belt, 4T	1	-	-
1	13041	WideTrac Chain & Belt, 6T	-	1	-
1	13445	WideTrac Chain & Belt, 8T	-	-	1
2	135-0942	Front Rubber Flap, 900X150	1	1	1
3	13041-2	WideTrac Idler Shaft	1	1	1
4	C22048 35	Idler Sprocket, 35mm Shaft, 6 Tooth	2	2	2
5	13041-4	Spacer Bush	2*	2*	2*
6	13062	Tensioner	2**	2**	2**
7	N20-SS	Nut, M20, Stainless Steel	4	4	4
8	13064	Tensioner Screw, M20X270	2	2	2
9	C22044A	Chain Joiner Link, 10mm	2	2	2

*Fitted to machines manufactured before July 2021

**Machines manufactured after July 2021 have spacer bush welded to tensioner

Floor Drive Components – Drive Assembly up to June 2023

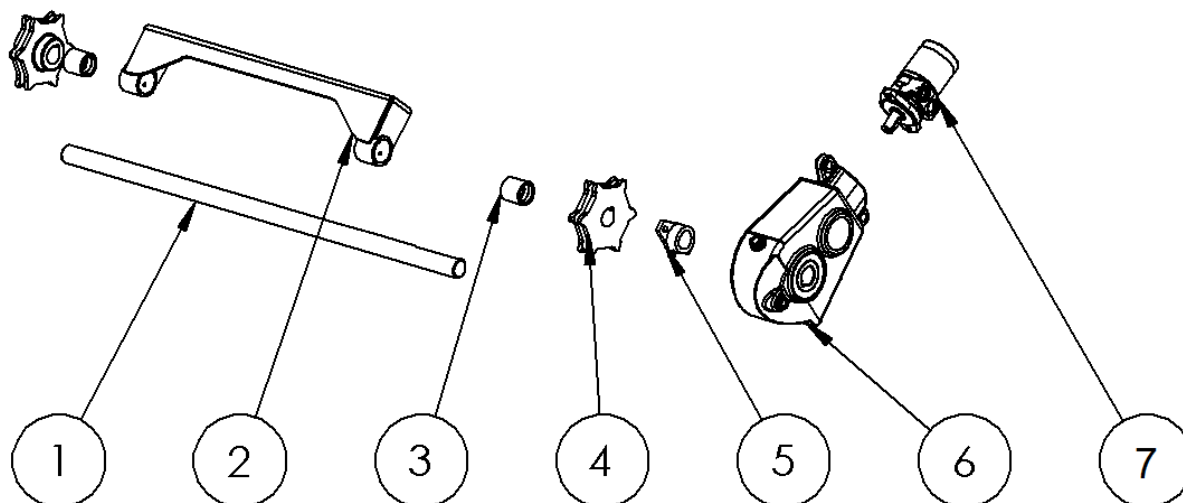

Applies to machines built up to June 2023. Up to Serial Number FOLF18550.

Item	Part Number	Description	Quantity		
			4T	6T	8T
1	13041-1	Driveshaft, 40mm	1	1	-
1	13441	Driveshaft, 45mm	-	-	1
2	13569	Driveshaft Bearing Assembly, Complete, 40mm	1	1	-
2	13568	Driveshaft Bearing Assembly, Complete, 45mm	-	-	1
3	40X50X50	Shaft Bush, 40mm	2	2	-
3	45X60X50	Shaft Bush, 45mm	-	-	2
4	C22025 40	Drive Sprocket, 40mm Shaft, 6 Tooth	2	2	-
4	C22025 45	Drive Sprocket, 45mm Shaft, 6 Tooth	-	-	2
5	C21011	Brass Bearing, 40mm, 2 Leg	1	1	-
5	13113	Brass Bearing, 45mm, 2 Leg	-	-	1
6	GBRT200-40-PT	Gearbox, Berma RT200-40	1	1	-
6	GBRT300-45-PT	Gearbox, Berma RT300-45	-	-	1
7	HYM195-SS	Hydraulic Motor, Parker TE0195, With Speed Sensor	1	1	1

Floor Drive Components – Drive Assembly after June 2023

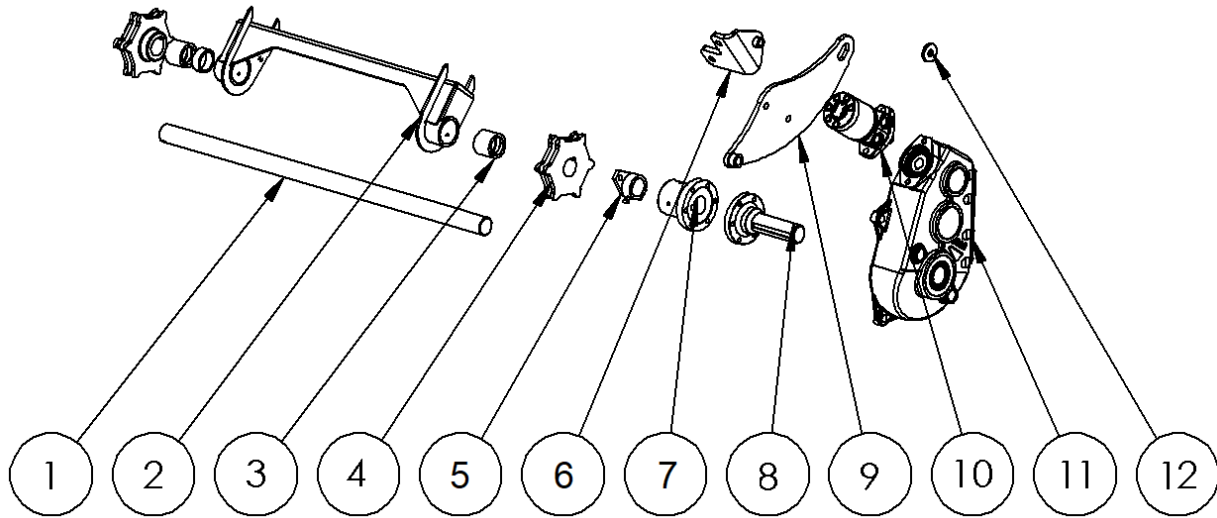

Applies to machines built after June 2023. From Serial Number FOLF18551 on.

Item	Part Number	Description	Quantity		
			4T	6T	8T
1	14625	Driveshaft, 45mm	1	1	1
2	14624	Driveshaft Bearing Assembly, Complete, 45mm	1	1	1
3	45X60X50	Shaft Bush, 45mm	2	2	2
4	C22025 45	Drive Sprocket, 45mm Shaft, 6 Tooth	2	2	2
5	13113	Brass Bearing, 45mm, 2 Leg	1	1	1
6	14660	GB mount	1	1	1
7	14623	Female half gearbox coupling	1	1	1
8	135-4142	Male 45mm half gearbox coupling	1	1	1
9	14656	Gearbox torque arm	1	1	1
10	HYM195-SS	Hydraulic Motor, Parker TE0195, With Speed Sensor	1	1	1
11	GBRT300-45-PT	Gearbox, Berma RT300-45	1	1	1
12	14659	Retainer washer	1	1	1

Spinner Assembly

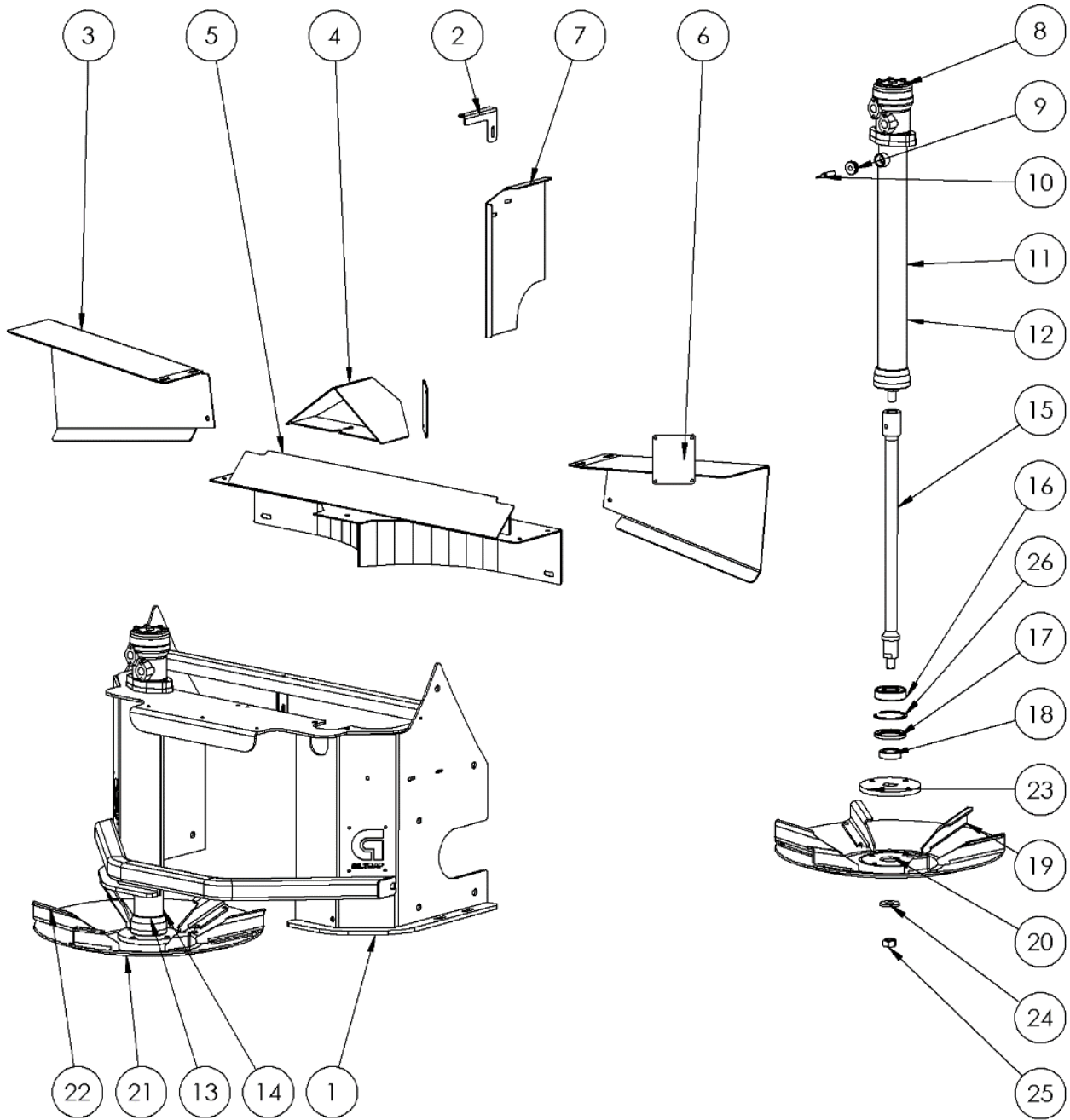

Item	Part Number	Description	Quantity
1	13037	Galvanised Spinner Frame – WideTrac	1
2	13036-3	Divider Plate Brace	1
3	13036-1L	LH Deflector	1
4	13039	Centre Divider	1
5	13038	Spinner Divider	1
6	13036-1R	RH Deflector	1
7	13036-2	Divider Plate	1
8	HYM32DAN-PT	Hydraulic Motor 32cc	2
9	135-4557	Sensor Bush	1
10	11654	Proximity Sensor, Spinner Speed	1
11	135-4112-RH	Spinner tube RH (With Sensor Mount)	1
12	13590	Spinner Tube Assembly, RH, Complete (w/ Sensor mount)	1
13	135-4112-LH	Spinner tube LH (No Sensor Mount)	1
14	13672	Spinner Tube Assembly, LH, Complete (No Sensor mount)	1
15	135-4102	Spinner Shaft	2
16	BRG6307	Bearing	2
17	SL558008	Seal	2
18	135-4200	Seal sleeve	2
19	13034	RH Stainless Spinner Disc, Complete	1
20	13033	LH Stainless Spinner Disc, Complete	1
21	12951-3	LH Spinner Vane	6
22	12951-2	RH Spinner Vane	6
23	135-1048	Spinner Mount Plate	2
24	135-1069	Spinner Disc Centre Washer	2
25	NN20	Nut	2
26	CC180	Circlip	2

Rear Door Assembly – Up to December 2022

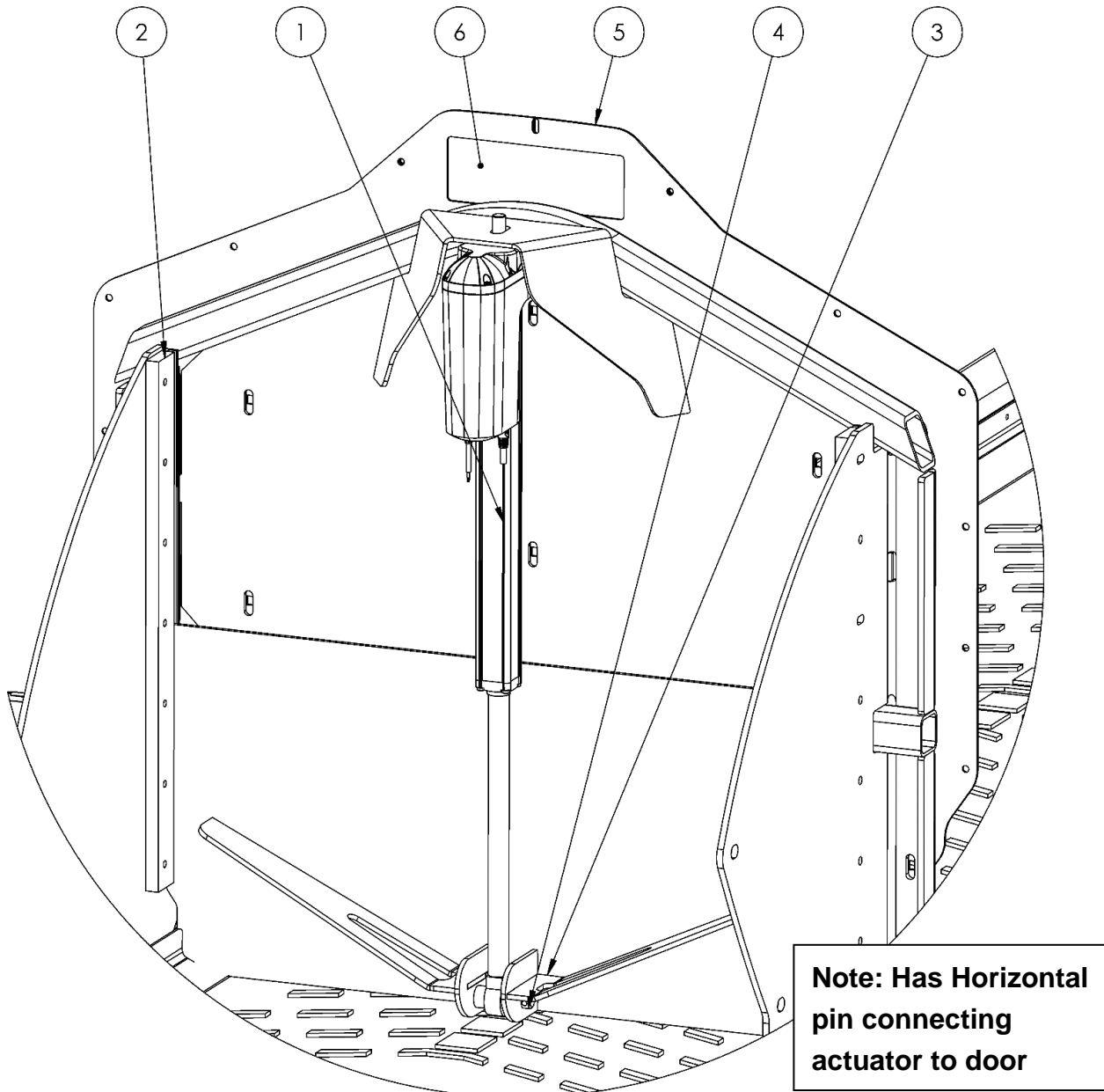

Item	Part Number	Description	Quantity
1	RAM-J14252-OM (see Note below)	Door Actuator, WideTrac Fert	1
2	10517	Door slide	2
3	13077	WideTrac Door	1
4	12018	WideTrac Door Pin	1
5	13063	Rear Bin Seal Plate	1
6	13067	Actuator Access Cover	1

Note: This style Actuator is not available. If actuator requires replacement, new style Actuator and new style Door must be fitted (see next page).

Rear Door Assembly – From December 2022

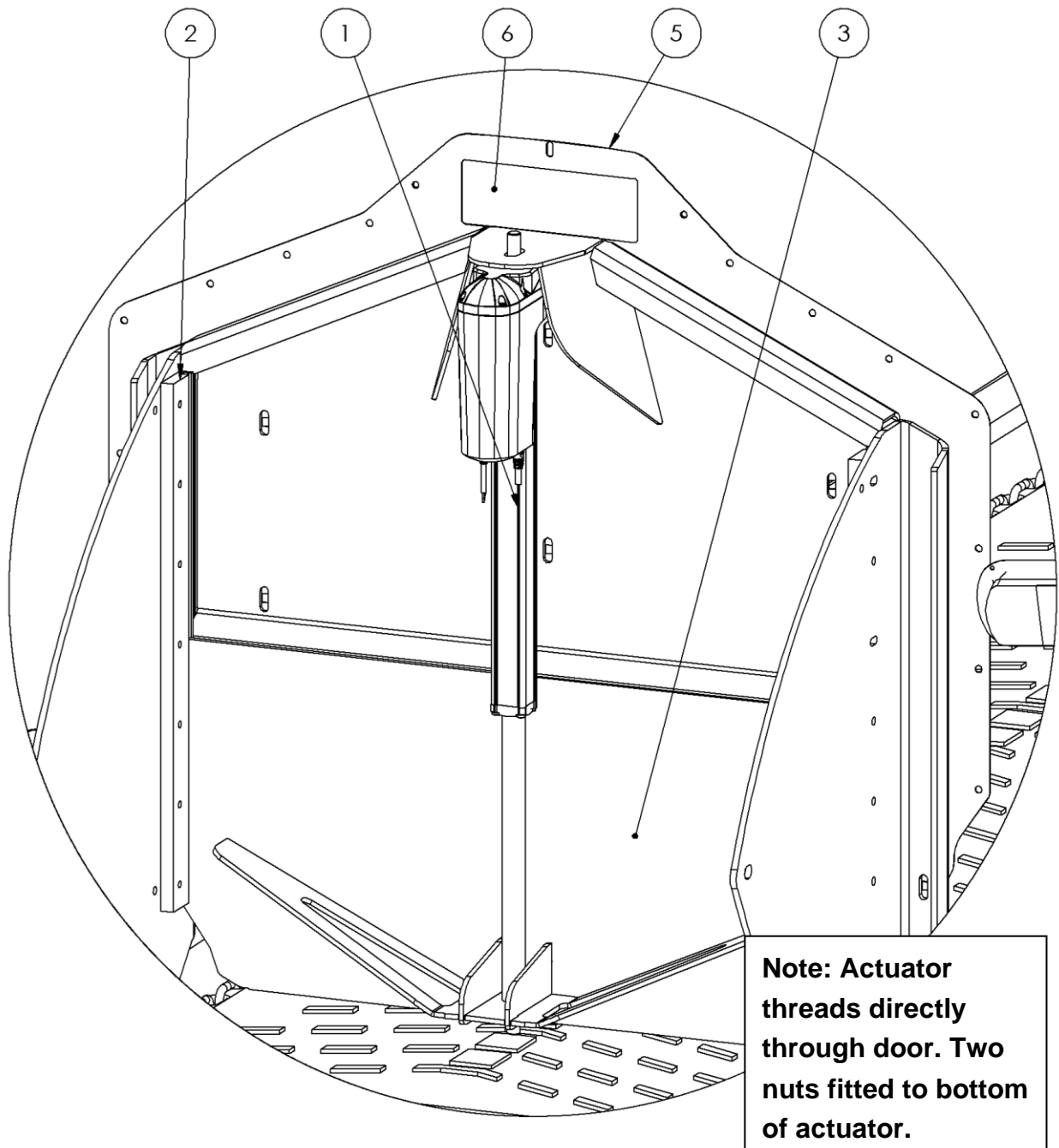

Item	Part Number	Description	Quantity
1	RAM-J14252	Door Actuator, WideTrac Fert	1
2	10517	Door slide	2
3	14202	WideTrac Door	1
5	13063	Rear Bin Seal Plate	1
6	13067	Actuator Access Cover	1

Axle Assembly

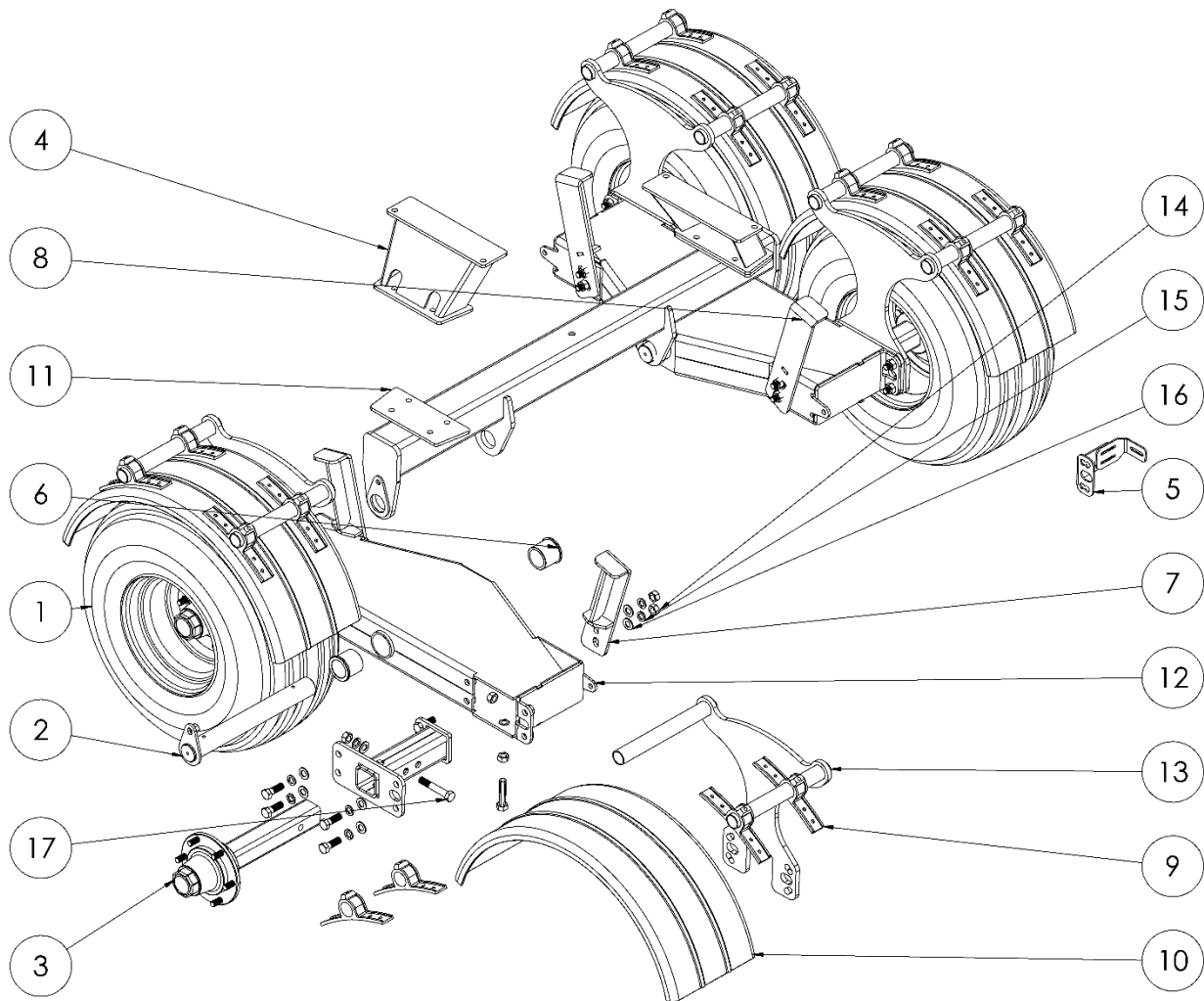

Item	Part Number	Description	Quantity		
			4T	6T	8T
1	WHLA11.5/80-12	Wheel Assy, 11.5/80 X 15.3, 6 Stud	4	-	-
1	WHLA400X15.5-146	Wheel Assy, 400/60 X 15.5, 6 Stud	-	4	-
1	WHLA400X55-22.5	Wheel Assy, 400/55 X 22.5	-	-	4
2	13109	Axle Shaft, 60mm	2	2	2
3	HUB3000KG	Hub & Stub, 70mm Square, 6 Stud	4	4	-
3	HUB4250KG	Hub & Stub, 80mm Square, 8 Stud	-	-	4
4	13411	Axle Spacer, 4T	2	-	-
4	13043	Axle Spacer, 6T	-	2	-
4	13444	Axle Spacer, 8T	-	-	2
5	13503	Wheel Speed Sensor Bracket	1	1	1

6	13110	Axle Bush, 60mm Shaft	4	4	4
7	13678-LH	Bump Stop, LH (Front RH Only)	1	-	-
7	13599-LH	Bump Stop, LH (Rear LH Only on 4T)	1	2	-
7	13594-LH	Bump Stop, LH	-	-	2
8	13678-RH	Bump Stop, RH (Front RH Only)	1	-	-
8	13599-RH	Bump Stop, RH (Rear LH Only on 4T)	1	2	-
8	13594-RH	Bump Stop, RH	-	-	2
9	MUDGUARD-SADDLE	Mudguard Fitting Saddle	8	8	8
10	13504	Plastic Mudguard, 11.5/80 & 400/60	4	4	-
10	PL 1204 RED	Plastic Mudguard, 400/55 X 22.5	-	-	4
11	13414-GV	Galvanised Axle Beam, SD, 1640mm	1	1	-
11	13448-GV	Galvanised Axle Beam, HD, 1640mm	-	-	1
12	13433-GV	Galvanised Offset Walking Beam, 975mm	2	-	-
12	12522-GV	Galvanised Walking Beam, 975mm	-	2	-
12	13457-GV	Galvanised Offset Walking Beam, 1200mm	-	-	2
13	13071	Mudguard Mount, 11.5/80 & 400/60	4	4	-
13	13592	Mudguard Mount, 400/55 X 22.5	-	-	4
14	N20	Nut, M20	32	32	32
15	WASG20	Spring Washer, M20 X 3mm, ZP	28	28	28
16	WA20	Washer, M20 X 39 X 3, Galvanised	28	28	28
17	B20X120	Bolt, M20 X 120, ZP	4	4	-
17	B20X130	Bolt, M20 X 130, ZP	-	-	4

Parts List applies to all machines fitted with standard wheel/tyre combination only

Hub Assembly – ADR

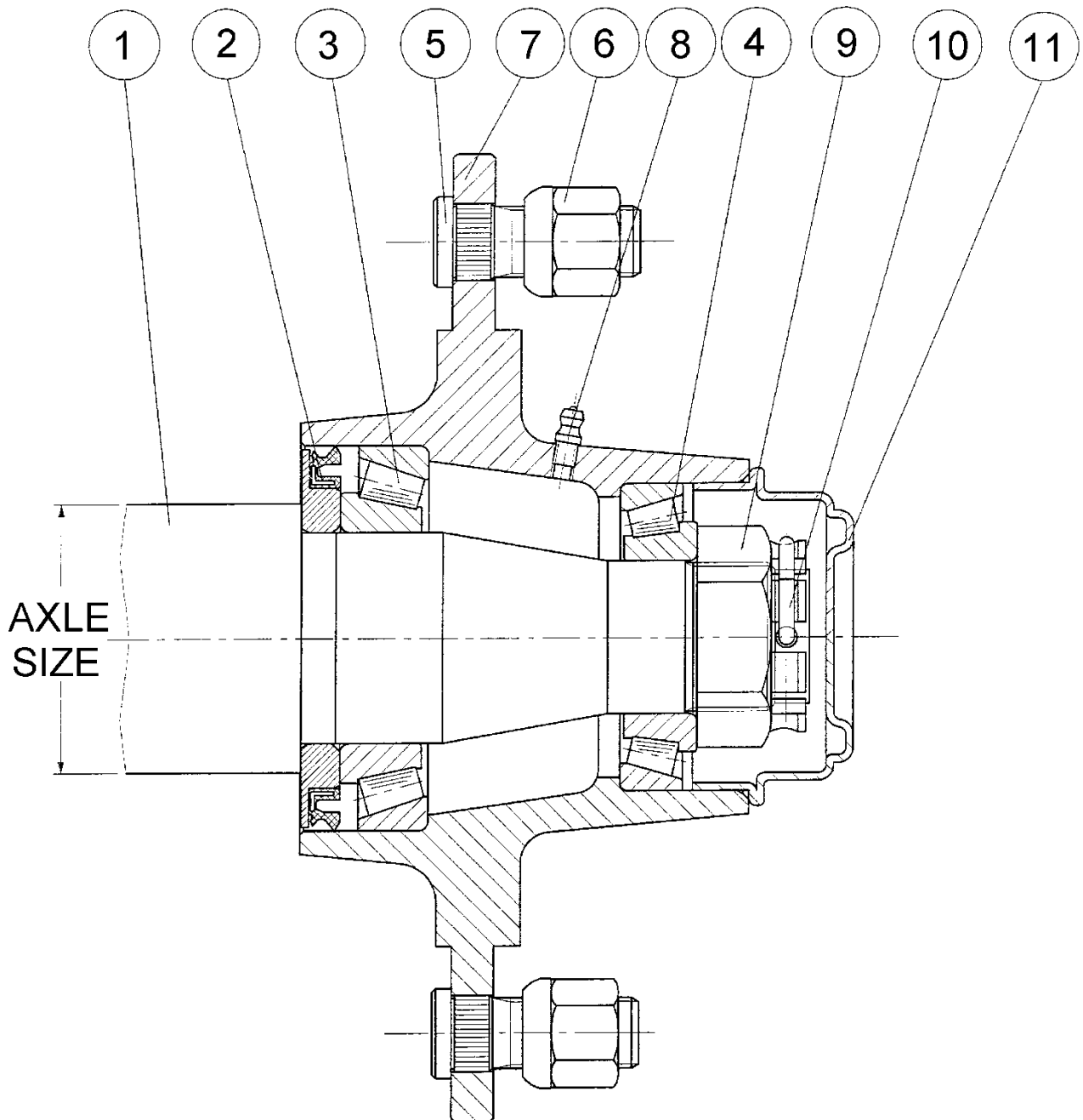

Item	Part Number	Description	Quantity		
			70mm	80mm	90mm
1	HUB2000KG	Complete Stub Axle, ADR 6 stud 60sq	-	-	-
1	HUB3000KG	Complete Stub Axle, ADR 6 stud 70sq	1	-	-
1	HUB4250KG	Complete Stub Axle, ADR 8 stud 80sq	-	1	-
1	HUB5000KG	Complete Stub Axle, ADR 8 stud 90sq	-	-	1
2	110-0193	Seal 57x100x10 O/A (80x100x8 nom.)	-	-	-
2	110-0194	Seal 67x120x12 O/A (100x120x10 nom.)	1	-	-
2	110-0195	Seal 78x130x10 O/A (108x130x8 nom.)	-	1	-
2	110-0196	Seal 82x140x10 O/A (119x140x8 nom.)	-	-	1
3	BRG30208J2	Taper Roller Bearing, 30208 J2	-	-	-
3	BRG32210J2	Taper Roller Bearing, 32210 J2	1	-	-
3	BRG32212J2	Taper Roller Bearing, 32212 J2	-	1	-
3	BRG32213J2	Taper Roller Bearing, 32213 J2	-	-	1
4	BRG30211J2	Taper Roller Bearing, 30211 J2	-	-	-
4	BRG30213J2	Taper Roller Bearing, 30213 J2	1	-	-
4	BRG32215J2	Taper Roller Bearing, 32215 J2	-	1	-
4	BRG32216J2	Taper Roller Bearing, 32216 J2	-	-	1
5	110-0945	Wheel Stud, M18x50	6	8	-
5	110-0950	Wheel Stud, M20x60x1.5	-	-	8
6	110-0917	Wheel Nut, M18	6	8	-
6	110-0919	Wheel Nut, M20x1.5	-	-	8
7	-	Hub Only	1	1	1
8	GRN8-45	Grease Nipple, M8x1.0 45 deg	1	1	1
9	110-1047	Slotted Nut, M39x1.5	1	-	-
9	110-1060	Slotted Washer Nut, M48x1.5	-	1	1
10	-	Retaining Clip (or Split Pin SP5x70)	-	-	-
10	-	Retaining Clip (or Split Pin SP5x70)	1	-	-
10	-	Retaining Clip (or Split Pin SP5x80)	-	1	-
10	-	Retaining Clip (or Split Pin SP5x90)	-	-	1
11	110-0799	Grease Cap ADR Pressed Steel - 80mm	-	-	-
11	110-0881	Grease Cap ADR Pressed Steel - 90mm	1	-	-
11	110-0883	Grease Cap ADR Pressed Steel - 110mm	-	1	-
11	110-0884	Grease Cap ADR Pressed Steel - 120mm	-	-	1

Gearbox Details – RT200

Oil replacement: SAE90 EP (2.3L)

Riduttore RT200 Ø45			
CODICE 9358			
Fig.	Rif.	Descrizione	Qt.
1	9360	Scatola RT200	1
2	8670-8	Mozzo Ø15	1
3	9347	Ruota dentata Z=53	1
4	8703	Seeger F 72	1
5	8702	Cuscinetto 60'13	2
6	3439	Seeger I 100	2
7	9346	Pignone di rinvio Z=10	1
8	9359	Corona Z=31	1
9	3401	Chavetta 10x8x25	2
10	3333	Cuscinetto 6207	1
11	3435	Seeger I 80	2
12	3434	Seeger I 72	1
13	3339	Cuscinetto 6307	1
14	9255	Pignone Z=10	1
15	1538	Cuscinetto 60'0	1
16	3428	Seeger E 50	1
17	8701	Anello di ten. 65/100/10	2
18	8243	Tappo Ø80 sp.10	1
19	8490	Tappo Ø72 sp.10	1
20	1257	Spia liv. olio Ø1/2"Gas	1
21	5689	Tappo sfiato Ø1/2"Gas	1
22	8671	Guarnizione x motore	1
23	9361	Guarnizione coperchio	1
24	9362	Coperchio	1
25	3284	Vite TE M8x15-8G	6

Gearbox Details – RT300

Oil replacement: SAE90 EP (3.8L)

Riduttore RT300 Ø45			
CODICE 8670			
Fig.	Rif.	Descrizione	Qt.
1	8669	Scatola RT300	1
2	8670-8	Mozzo Ø45	1
3	8670-6	Ruota demata Z=46	1
4	3439	Seeger I 100	2
5	8702	Cuscinetto 60*3	2
6	8670-5	Pignone di rinvio Z=12	1
7	8670-4	Ruota demata Z=50	1
8	4174	Chiavetta 12x8x30	1
9	3342	Cuscinetto 6208	2
10	3435	Seeger I 80	3
11	8670-3	Pignone di rinvio Z=10	1
12	8670-2	Corona conica Z=43	1
13	3396	Chiavetta 8x7x25	1
14	8596	Cuscinetto 6305	2
15	3433	Seeger I 62	2
16	8670-1	Pignone 7=2R	1
17	1538	Cuscinetto 60*0	1
18	3428	Seeger E 50	1
19	8701	Anello di ten 65/130/10	2
20	8243	Tappo Ø80 sp.10	2
21	8625	Tappo Ø62 sp.10	2
22	8668	Coperchio RT300	1
23	8668-1	Guarnizione coperchio	1
24	9175	Tappo Ø1" Gas	1
25	1831	Spia liv. olio Ø1"Gas	1
26	3284	Vite TL MDx16-0C	8
27	8703	Seeger E 72	1
28	8671	Guarnizione x motore	1

Roll Over Cover

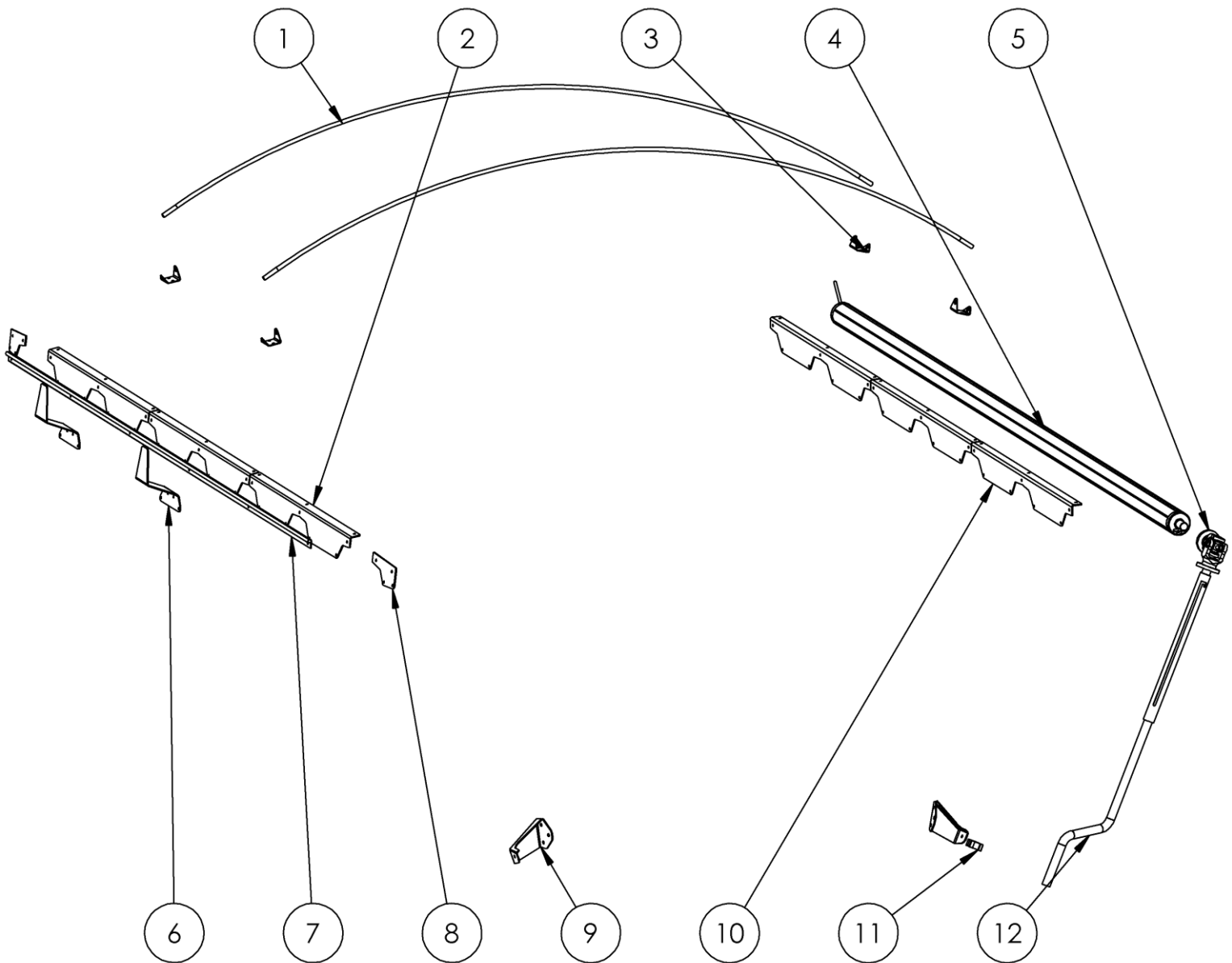

Item	Part Number	Description	Quantity		
			4T	6T	8T
1	RODFIB12	Fibreglass Rod, 12mm	1 x 3.85m	2 x 3.85m	3 x 3.85m
2	13050	Roll Over Cover Mount, RH	2	3	4
3	13593	Fibreglass Rod Mount	2	4	6
4	AL34049	Aluminium Extrusion 34049 Tube	2.11m	3.00m	3.89m
5	GBBA165002	Universal Joint 25mm	1	1	1
6	13066	Roll Over Cover Stop	2	2	3
7	AL6595	Aluminium Extrusion 6595	2.11m	3.00m	3.89m
8	13696	End Trim	2	2	2

9	13068	Cover Handle Mount	2	2	2
10	13049	Roll Over Cover Mount, RH	2	3	4
11	135-4528	Pipe Clip, Plastic, 25mm	2	2	2
12	135-0681	Winding Handle Assembly	1	1	1
13	COVER4TF-WT	Cover only, WideTrac, 4T	1	-	-
13	COVER6TF-WT	Cover only, WideTrac, 6T	-	1	-
13	COVER8TF-WT	Cover only, WideTrac, 8T	-	-	1
*	FERTCOV-4T-WT	Roll Top Cover Option – 4T	1	-	-
*	FERTCOV-6T-WT	Roll Top Cover Option – 6T	-	1	-
*	FERTCOV-8T-WT	Roll Top Cover Option – 8T	-	-	1

Troubleshooting

Problem	Cause	Solution
Controller Not Switching On	Faulty battery connection	Check power plug between tractor and spreader and connection to battery
	Remote battery flat	Check if controller will switch on using power button on controller. If controller powers on, replace remote battery
	Blown fuse	Replace 30A fuse in battery loom
Spinners Not Spinning	Incorrect flow direction	Reverse hydraulic flow to machine
	Spinner speed knob adjusted too far in	Wind spinner speed knob out (CCW)
Spinners Not Rotating Fast Enough	Low oil flow	Check tractor hydraulics are adjusted correctly. Connect spinner motors in series
	Excessive hydraulic backpressure	Connect blanked length of hose to ACC port on valve block
Spinners Spinning too fast	Excessive hydraulic flow	Reduce hydraulic flow from tractor
	Spinner speed knob adjusted too far out	Wind spinner speed knob in (CW)
Spinners Surging While Operating	Excessive hydraulic backpressure	Connect blanked length of hose to ACC port on valve block
Spreading Intermittently or ground Speed is Reading Inconsistently	Faulty wheel speed sensor connection or wiring	Check sensor connector and wiring – replace if necessary
	Damaged speed sensor	Replace sensor
	Incorrectly set speed sensor	Set sensor face 2mm from back of wheel studs
Application Rate is Incorrect or Inconsistent	Incorrect spreading parameters	Check product density, spread rate, and spread width
	Wheel speed sensor not reading correctly	Check wheel speed sensor
	Belt speed not calibrated	Run belt calibration
Spreader stays on “Ready to Spread” screen after driving forward	Wheel speed sensor not reading correctly	Check sensor is not damaged and is set to correct distance from back of wheel studs
Screen shows “Actuator Error”	Damaged wiring/connection	Check actuator wiring and connections on rear of control panel, rear junction box, and actuator unit.
	Blown actuator fuse	Check 30A fuse behind front control panel.

Notes